

# WELCOME TO WINDYCON 36!

When I was given the honour of chairing WindyCon 36, I immediately knew I wanted Steampunk as a theme. Yes, the costuming potential is the most obvious attraction. But for many of us, steampunk runs a lot deeper than corsets and goggles. I have always been fascinated by the anachronistic technological aesthetics involved in recreating something very modern with plastic and brushed aluminum replaced with hardwood and brass. The heights of twenty-first century technology envisioned in a nineteenth century light. The fusion of art and science, form and function being of equal importance.

And lest one forget the “punk” in steampunk, there is the delicious rebellious streak running counter to the restrictive neo-Victorian ethic.

During the convention, you will see our theme explored in many different ways. We have introduced a steampunk LARP for interactive participation. Our new anime track, along with our traditional films, will cover a wide range of visuals. Our Guests of Honour will entertain you with art, literature, and music demonstrating steampunk aesthetics. Editors, authors, speakers, and presenters of all stripes will explore the genre in as many ways as possible. And the most marvelous attire will be seen at our masquerade. There will even be airship races before everything is said and done. And yet, all of this is just a taste of what steampunk can mean.

The rest of the pages you now hold contain descriptions of all of the wonders of this weekend: the programming items, the special events, the art show, and dealers room. I recommend taking a few minutes to go through it, as that information will offer you a better insight into the convention than the ramblings of the chair.

One of many groups working to help those hurt by the current economic climate is our charity, People’s Resource Center. They will be at the convention during the weekend. I ask that you stop by and talk with them. The work they do for so many with so little is amazing, and any help or assistance you can offer them will be deeply appreciated.

In closing, I thank everyone who has contributed to making WindyCon 36 a reality. The committee, staff, and volunteers have forged order out of my chaos, given form and substance to my most outlandish ideas, and worked nothing short of miracles this past year. You, my friends, are the best and deserve much more than my humble praises.

*Joseph “Uncle Vlad” Stockman  
Chair – WindyCon 36*

# TABLE OF CONTENTS

## GENERAL INFORMATION

Department Hours .....	2
Convention Rules .....	2
Hotel Map .....	3
Welcome to ISFiC .....	5
Restaurant Guide.....	43
Staff List.....	47

## GUEST BIOGRAPHIES

James P. Blaylock.....	7
Phil Foglio .....	9
Kaja Foglio.....	11
Tom Smith.....	13
Chris Garcia .....	15
Christian Ready.....	17

## DEPARTMENT INFORMATION

Dealers.....	6
Ombudsman .....	6
Masquerade .....	10
Art Show.....	14
Kids Programming.....	18
Gaming.....	22
Special Events.....	22
Con Suite.....	26
Films .....	30
Anime .....	34
Parties .....	38

## PROGRAMMING

Friday .....	19
Saturday .....	21, 23 & 25
Sunday .....	27 & 29

## ISFiC WRITERS CONTEST WINNER

<i>Oracle</i> by John M. Cowan.....	31
-------------------------------------	----

# RULES

We at WindyCon take the rules of propriety very seriously. While it is understood that there is a certain level of non-conformity inherent in our attendees, we expect each guest to govern themselves and follow the rules.

This is our second year in our new venue, and we could not be more pleased. We ask that you continue to respect the facility and its employees. We hope to have a long and happy stay in our new home.

If you have any questions or problems, stop by Operations. They are the communication center of the convention and can either answer your question or direct you to someone who can.

You must have your badge with you at all times in order to enter or stay in any convention function. You must present your badge to any member of the staff, including our door guards, who request it. A lost badge may be replaced at Registration for the cost of an at the door badge.

We understand that many of you will wish to carry about your latest weapon. Sadly, both the hotel and the local constabulary have asked that we impose what we hope are some reasonable limitations. First and foremost, use common sense. Do not raise a weapon in anger. Do not use a weapon of any type against the people or property around you. Real or realistic firearms are expressly forbidden under all circumstances. Likewise, all projectile-throwing machines are to be kept out of the convention areas. All edged weapons, sharpened or not, must remain sheathed and secured while worn or carried. Energy weapons are restricted to visible-light lasers (400–700 nm) of up to 1 mW continuous wave. WindyCon reserves the right to prohibit any weapon, real or not, at its sole discretion.

Our venue has a restriction allowing only dogs on the property; no cats, rats, elephants, snakes, ferrets, unicorns, etc. are allowed. If you have a dog accompanying you, you must take it from your room for its walk and then back to your room. The only exception are dogs who are also service animals, meaning they have been trained in obedience and task skills to meet the needs of a disabled person. If you bring your canine service animal into convention space, please make certain it is properly harnessed and identified according to the relevant statutes.

While the smoking of tobacco and related herbs remains in fashion in certain circles, it is prohibited by local law and ordinance within the convention facilities. There are designated areas with the appropriate refuse bins for those who wish to indulge outside. Please respect those not wishing to indulge with you and keep the specified distance away from the doors.

WindyCon reserves the right revoke the membership of anyone failing to conform to the letter and spirit of these policies, those of our hotel and the laws of the State of Illinois.

# HOURS

## CON SUITE

### Friday

11:00 am - 12:00 noon Staff and Merchants only.  
12:00 noon - 3:30 am All Travelers with Con Badge  
3:00 pm - 3:00 am Bheer Available (ID Required)

### Saturday

9:00 am - 9:30 am Staff and Merchants only.  
9:30 am - 3:30 am All Travelers with Con Badge  
3:00 pm - 3:00 am Bheer Available (ID Required)

### Sunday

10:00 am - 10:30 am Staff and Merchants only.  
10:30 am - 3:00 pm All Travelers with Con Badge  
12:00 noon - 2:00 pm Bheer Available (ID Required)

## DEALERS

**Friday** 3:00 pm - 7:00 pm

**Saturday** 10:00 am - 6:00 pm

**Sunday** 11:00 am - 3:00 pm

## ART SHOW

### Friday

1:00 pm - 4:00 pm Artist setup only  
4:00 pm - 9:00 pm Open to WindyCon attendees  
9:00 pm - 10:00 pm Wine and Cheese Reception.  
Meet the Artists

### Saturday

10:00 am - 6:30 pm Open to WindyCon attendees  
12:00 noon Quick Sale opens  
8:00 pm - ??? Art Auction  
10:00 pm-ish We will attempt to start art pickup

### Sunday

10:00 am - 2:00 pm Art pickup and artist checkout only  
Print Shop Open

## COMPUTER GAMING

**Friday** 8:00 pm - 2:00 am All ages

**Saturday** 11:00 am - 1:00 pm Kids games only  
1:00 pm - 2:00 am All ages

**Sunday** 11:00 am - 1:00 pm Kids games only,  
1:00 pm - 3:00 pm All ages

# MAP OF THE FACILITIES

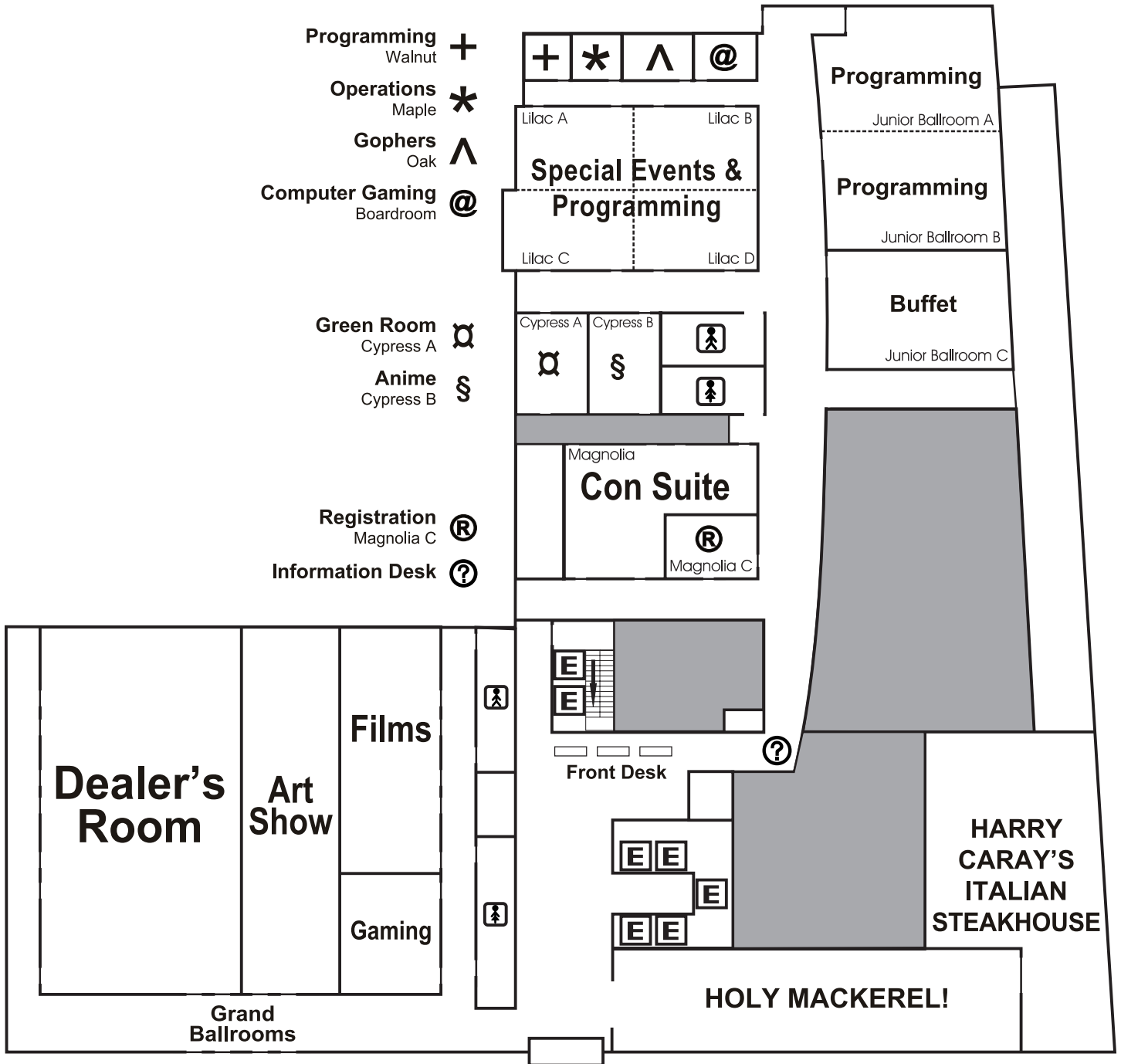

# ISFiC Press Presents

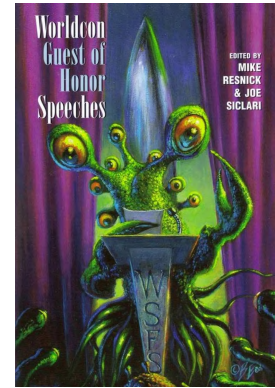
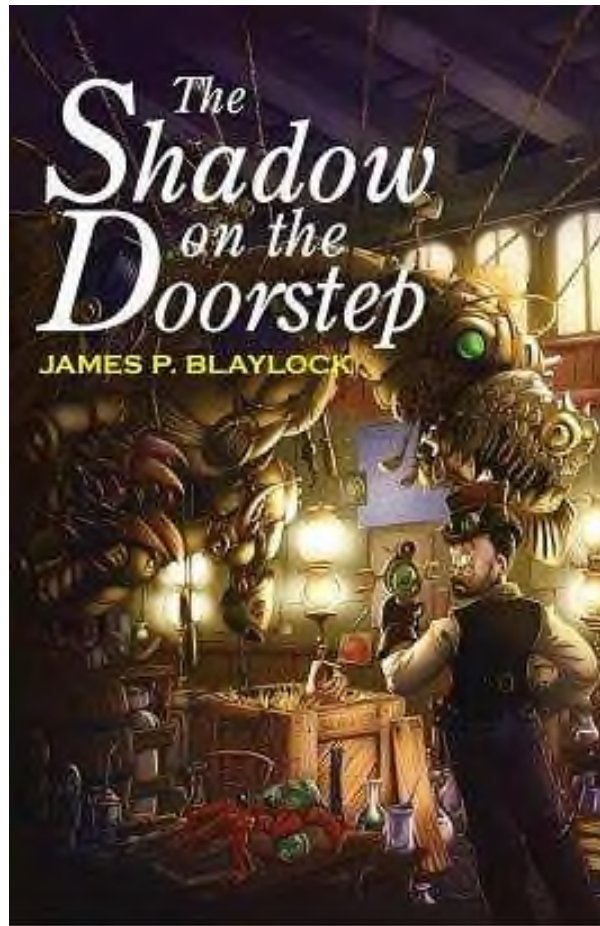
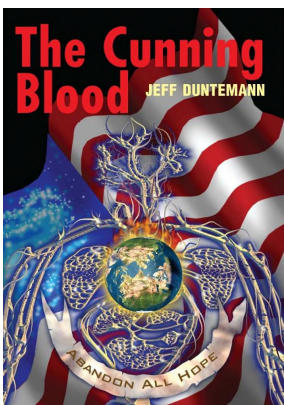
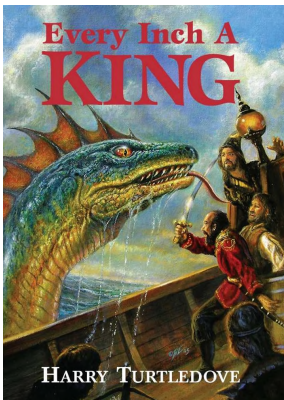
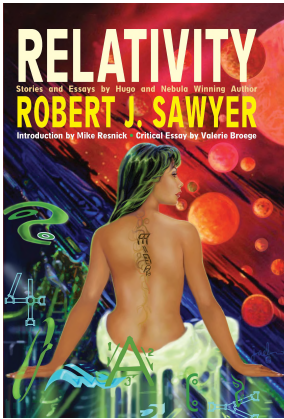

Our newest book

*The Shadow on the Doorstep*  
by James P. Blaylock

An author's choice collection of thirteen  
fantastic stories

With an introduction by Tim Powers and  
an afterword by Lewis Shiner

*Available in the Dealers' Room  
or through  
<http://www.isficpress.com>*

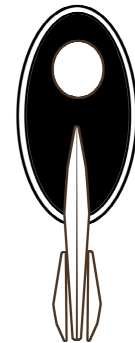

# WELCOME TO ISFiC

**Steven H Silver**

*with guidance from Ross Pavlac*

Congratulations, you are a member of ISFiC, one of Chicago's oldest science fiction organizations. So, what does that mean?

When you pay to join WindyCon, you're actually joining ISFiC, the organization that runs WindyCon and continues to have a presence throughout the rest of the year. Your membership in ISFiC allows you to attend other ISFiC events.

In 1962, Chicago fandom brought the world together for the twentieth World Science Fiction Convention, known variously as Chicon II or Chicon III. After that event, which boasted a massive membership of 550 people, Chicago fandom splintered. Although there were some fannish activities, such as Advent: Publishers or small get-togethers, Chicago fandom entered a period of dormancy.

ISFiC, Illinois Science Fiction in Chicago, was founded in the early 1970s by a group of science fiction fans who decided that it would be a good idea to get con-running experience so they could run a Worldcon. They later realized that this was a silly thing to do, but by that time, they had founded WindyCon, a general science fiction convention held for the first time October 25-27, 1973 at the Blackstone Hotel in Chicago. Joe Haldeman and Lou Tabakow were the guests of honor and Bob Tucker served as toastmaster.

The original board of directors of ISFiC was made up of Larry Propp, Mark and Lynn Aronson, Ann Cass, Jon and Joni Stopa, and Mike and Carol Resnick. Under their early guidance, WindyCon became an annual event, with the Aronsons chairing the first three events before passing the chairmanship reins on to Larry Propp, who would use his knowledge to co-chair Chicon IV in 1982.

Although ISFiC was organized, in part to help run conventions to give people experience for a Worldcon and bring Chicago fandom together, ISFiC has never actually run a Worldcon, leaving that activity up to individually created organizations.

So, what does ISFiC do when it isn't running WindyCon?

After Chicon IV, ISFiC had successfully attained the goal of building an ongoing committee that could run WindyCon from year to year, at least, as much as any local group can be said to. ISFiC thought about what could be done to make WindyCon a better convention.

One factor in this was that WindyCon's excess funds were starting to pile up. As a 501(c)3 corporation, ISFiC is supposed to use the excess funds for the benefit of fandom. So, rather than let the money pile up, ISFiC decided to put the money back into WindyCon in creative ways.

One way was in providing grants to WindyCon to bring in special guests over and above the normal guests of honor. In this manner, WindyCon was able to compensate for the fact that most SF authors and editors live on the East and West Coasts. Once ISFiC started bringing in authors and editors, many liked WindyCon so much that they have continued coming back on their own accord.

ISFiC looked further afield and also provided grants to other groups in Illinois that wanted to help increase the range, breadth, and depth of fandom. Other conventions, both in Chicagoland and downstate came to ISFiC looking for either money or resources. ISFiC's charter made providing this assistance a key goal. Some of the other organizations that have benefited from ISFiC largesse include Chambanacon, Whatcon, Capricon, Duckon, Think Galacticon, and the Speculative Literature Foundation.

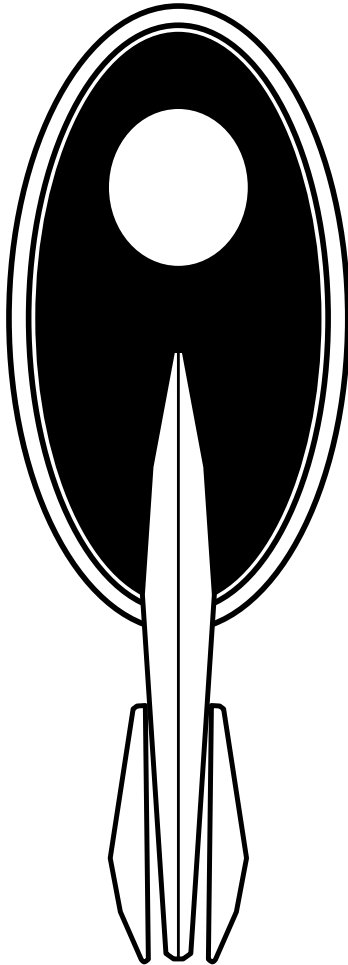

Not just financial assistance is given. In some cases, the WindyCon art show hangings are rented for a nominal fee (to cover maintenance and upkeep costs). ISFiC is always interested in hearing from groups running Illinois conventions that have a specific project they would like some assistance with.

While ISFiC was running a convention in November, many of the people who ran the convention realized that even though they got to see fleeting glimpses of friends, their con-running duties kept them too busy to fully socialize. Looking for another excuse to get together for fannish camaraderie, and because there was no summer Chicago con at the time, in 1986, ISFiC created Picnicon, an annual picnic held in a variety of forest preserve and parks over the years. As a relaxacon, ISFiC provides the hamburgers, hotdogs, and grills and asks the attendees to drop a couple (literally) bucks in the hat and bring a side dish or dessert. Think of Picnicon as a massive outdoor con suite.

Also, in 1986, ISFiC elected to run an amateur writers contest, open to all members of ISFiC (WindyCon), or people living in Illinois or a bordering state (including Michigan, 'cause on a clear day you can see it across the lake). That first year, the contest was won by Richard Chwedyk, who would go on to become a professionally published author and winner of a Nebula Award. The ISFiC Writers Contest is held most years in conjunction with WindyCon. The winner receives con membership, a gold coin, and publication of their story in the ISFiC Program book.

In 2005, ISFiC created ISFiC Press. Each year, this arm of ISFiC publishes a hardcover book at WindyCon, generally, but not always, by the WindyCon author guest of honor with a cover by the WindyCon artist guest of honor. ISFiC Press's first book, *Relativity*, by Robert J. Sawyer, received an Aurora Award, the Canadian National Award presented by fans. In addition, ISFiC Press has published unrelated science fiction novels and the Hugo Award-nominated *Worldcon Guest of Honor Speeches*.

The ISFiC board of directors has nine members, with three directors coming up for re-election each year for a three-year term. Any Illinois fan who is a member of ISFiC (see the first paragraph of this article) is eligible to be elected; come to the ISFiC board meeting at WindyCon (held on Saturday afternoon) and nominate yourself. Meetings of the ISFiC board are normally held at WindyCon and Capricon. The meetings are open to the public.

# DEALERS

**Friday** 3:00 pm - 7:00 pm  
**Saturday** 10:00 am - 6:00 pm  
**Sunday** 11:00 am - 3:00 pm

The Dealer's Room for this year is located in part of the Grand Ballroom on the main level of the hotel. There you will find about forty eager sellers willing and able to trade you treasures for your money. Remember that the holiday season will be just down the road (and creeping rapidly up on us), and that it is NEVER too early to begin shopping for fannish family, fannish friends, and (even) fannish you!

SMOKING IS NOT PERMITTED IN THE DEALER'S ROOM. Eating and drinking in the room are also not permitted in the room (except for Dealers while they are behind their own tables). Browsing, shopping, perusing, and free spending are permitted and also encouraged!!

A room layout and dealer location guide is available outside the Dealer Room.

# OMBUDSMAN

Hello and welcome, from your Ombudsman. This is a new position added to the convention this year. For those of you who do not know what an ombudsman is...

An ombudsman is a person who acts as a trusted intermediary between an organization and some internal or external constituency while representing the broad scope of constituent interests. The ombudsman may, for example, investigate constituent complaints relating to the organization and attempt to resolve them, usually through recommendations.

In other words if you have a problem with the convention, or if there is some thing you like and want to see it return, or if you have a suggestion, I am the person to find. I will be camped out quite a bit in the lobby or you can go to Operations and ask them to page me. I will have the ear of the conchair and we will be discussing how to implement your concerns and suggestions in the coming years.

I look forward to speaking to anyone with constructive suggestions or criticisms. I want everyone to have a great WindyCon!!

*Hugs and Fairie Dust...*  
**Sunshine**

# JAMES P. BLAYLOCK

by Tim Powers

I first met Jim Blaylock in 1972, when we were both English Literature majors at California State College in Fullerton. K. W. Jeter was also a student there, and we were all trying to get stories published. This seemed naturally to involve lots of trips to vast old used bookstores that aren't there anymore, and endless hours over endless pitchers of beer.

Somehow we did manage to get things published. Blaylock's first story appeared in *Unearth* magazine in 1976, and in the thirty-four years since then he's published fifteen novels and four collections of short stories, and twice won the World Fantasy Award.

Now he and I are teachers at a "high school of the arts," where we're encouraging a bunch of eerily-brilliant youngsters to forego "young urban professional"-type employment (though irregular employment is okay) and devote themselves to the chaotic career or writing. Sometimes I think we're a bad influence.

But it worked for us. You'd never have guessed, in 1972, that Blaylock was destined to be one of the best living writers of fantasy and science fiction. He looked like, and was, a surfer who was always getting up before dawn to drive a weird old Volkswagen with a surfboard on top to some Godforsaken beach. I was more the "meet you at noon for beers" type.

His nominal job was construction-cleanup, and he was forever driving around in a big old truck with a yard-long gearshift and a million empty donut bags under the seat, knocking down garages and cutting the roofs off of houses, sometimes the wrong ones by mistake.

While I came to our field by way of writers like Lovecraft and Leiber and Sturgeon, Blaylock came to it through writers like Robert Louis Stevenson, and William Gerhardt, and especially Laurence Sterne, whose crazy novel *Tristram Shandy* seems to have polarized Blaylock from an early age.

Blaylock was arguably the first modern writer to venture into what's now known as "Steampunk," a term Jeter made up as a joke. Well, maybe Michael Moorcock was first, but Blaylock's elaborate Victorian story "The Ape-Box Affair" appeared in *Unearth* magazine in 1978. Arguably all of his stories, even the contemporary ones, have a "Steampunk" element to them, with their solemn scientific theories that, upon reflection, seem substantially more splendid than feasible.

I forgot to mention that he also came by way of Dickens, Wells, and Verne. And he was a close friend of Philip K. Dick's for the last ten years of Dick's life. These all figure.

He's been married to Viki for 37 years and they have two sons in their late twenties. He's an expert carpenter, and has single-handedly added rooms and a second floor to their house. His under-the-stairs office is crowded with books, and old glass paperweights, and tiny and vaguely sinister-looking antique toys.

If you haven't read *The Last Coin* or *Knights of the Cornerstone*, pick them up in the dealer's room. Read the collection of his extraordinary stories that the convention is publishing. Buy him a beer and get him talking.



## Author Guest of Honour



# People's Resource Center thanks WindyCon for its support!!

People's Resource Center (PRC) has been meeting the needs of DuPage families in need since 1975. Services include DuPage County's largest food pantry, a free clothes closet, emergency assistance, literacy classes, computer training, art enrichment, job search assistance and other programs to help people meet their basic needs and take steps toward a brighter future. Last year, more than 28,000 DuPage County residents found help at both PRC locations, in Wheaton and Westmont.

To do our work, PRC relies on the efforts of 16 Board members, 28 staff members, 1,000 volunteers and partner agencies throughout the county. It exists to respond to basic human needs, promote dignity and justice, and create a future of hope and opportunity for the residents of DuPage County through discovering and sharing personal and community resources.

We thank you all for your generosity. To volunteer at PRC or to make a donation, visit [www.peoplesrc.org](http://www.peoplesrc.org). Or mail your donation (payable to People's Resource Center) to 201 S. Naperville Road, Wheaton, IL 60187.

[www.peoplesrc.org](http://www.peoplesrc.org)  
(630)682-5402

Here are a few more ways you can help PRC this holiday season:

**Thanksgiving:** Every \$15 you donate will provide a family with a special choice of classic Thanksgiving "trimmings", their choice of familiar ethnic foods and a grocery gift card worth enough to buy a turkey! (Be sure to write "Thanksgiving" in the memo section of your check.)



**Share the Spirit:** People's Resource Center's Share the Spirit program will collect brand new toys & gift certificates and distribute them to over 750 DuPage County families in need.

\* **Provide gift items:** Deliver brand new unwrapped toys or gift certificates to the DuPage County Fairgrounds (not PRC) at 2015 W. Manchester Road, Wheaton, IL 60187 on Sunday, December 6, 2009 – 9 am to 5 pm.

\* **Volunteer:** To volunteer during Share the Spirit, please call (630) 682-5402 x325. Leave your name, phone number, and the best time to reach you. You'll be contacted in early





# PHIL FOGGIO

## *Artist of Genius*

by Bill Higgins

When I first encountered Phil Foggio, he seemed to be everywhere in fandom: performing comedy with Moebius Theatre, co-publishing the fanzine *Effen Essef*, drawing a million cartoons for other fanzines, hanging hilarious plates (yes, I said plates) in convention art shows. Phil and Doug Rice shared an apartment at 7660 North Sheridan, a crossroads where Chicago fans often gathered.

It was in Phil's bathroom that I first discovered *Brewer's Dictionary of Phrase and Fable*, the perfect bathroom book. You can read a little, or you can read many pages, it's always interesting. He also had a copy of *Mrs. Byrne's Dictionary of Unusual, Obscure, and Preposterous Words* in there. Phil loves books.

Phil had art books, of course, but his place was also filled with science books, history books, science fiction, fantasy, and (it will not surprise you to learn) many volumes of prose by the great humorists. It was a fine collection then, and I suppose it has grown since.

Meanwhile, he was launching a career. I saw him win the Hugo Award for Best Fan Artist in 1977, and again in 1978. One cannot eat a Hugo, but soon Phil was drawing "What's New," a monthly comic strip for *The Dragon*, and providing artwork to the burgeoning gaming industry. Book covers, comics, and a novel followed.

Phil took great delight in hosting poker games for writers, artists, and fellow oddballs. The stakes might have been small, but the banter was priceless. Some of the regulars were ferociously enthusiastic card players, and when their deal came, they would declare the game to be some complicated variation I never heard of — with twos and one-eyed jacks wild — with a name like "Cincinnati Five-Way" (perhaps I am confusing this with the chili at Steak n Shake). It was bewildering.

One night, in self-defense, when the cards came to me, I created "Fibonacci" (five-card stud, but five cards in a Fibonacci series beat anything, and high Fibonacci beats a low Fibonacci). This drew groans from the Serious Players, but grins from the computer geeks at the table. I lost money nevertheless.

Phil moved to New York for a few years. He returned to Chicago with a snake. He moved in with Jim Fuerstenburg.

At some point, the snake escaped. He was probably somewhere in the building, but Phil and Jim were reluctant to knock on the doors of their neighbors and say, "We lost an eight-foot boa constrictor. Have you seen him?" So they kept quiet, hoping that the snake would show himself.

And lo, it came to pass that the snake did return. Jim was alone in the apartment at the time. He coaxed the snake into a laundry basket and put a piece of plywood on top. When Phil came home, Jim announced triumphantly, "I found your snake!" "Really?" said Phil. "Where is he?" "In this basket," said Jim, leading Phil to the basket.

Jim lifted the board to show Phil the snake.

Phil's face fell.

"That's not MY snake."

Later Phil told me, "For just about ten seconds, I really had him going..."

Eventually, we lost Phil to Seattle. I can't really regret that, though, because there he met Kaja. Who is truly wonderful. Elsewhere in this booklet, Alice Bentley will tell you about Kaja. Both Phil and Kaja contributed paintings to the popular card game *Magic: The Gathering*.



## *Artist Guest of Honour*

Together, in spare moments over the years, they planned and (literally) plotted a grand series of comics. As the new millennium dawned, they unleashed *Girl Genius* upon an unsuspecting world. How good is it? This year the Foglios added another Hugo — the first ever for Best Graphic Story — to their collection.

*Girl Genius* spinoffs include paper dolls, mugs, and radio plays. With Othar's Twitter, Phil and Kaja may have invented a new literary form: the novel with 140-character chapters.

They are raising two children, who believe it is completely normal for Mom and Dad to hang around the house all day long drawing comics. Phil serves as advisor to the Comics Club at school. The kids there draw their own comics. So if, at the beginning of the 22nd Century, art critics rhapsodize about the radical Seattle School that revolutionized comics, you'll know whom to thank.

Now WindyCon has invited Phil and Kaja to return to the City of the Big Shoulders. I hope you get an opportunity to meet them this weekend.

And if you visit my house, you'll find *Brewer's Dictionary of Phrase and Fable* in the bathroom. I have Phil Foglio to thank for that.

# MASQUERADE

## Saturday

5:00 pm	Masquerade Paperwork Due
7:00 pm	Green Room Opens for Pre-Judging
7:45 pm <i>Sharp!</i>	Clockwork Catwalk Lineup
8:00 pm	Masquerade Begins
9:45 pm	Masquerade Awards Ceremony

*Local Chrono-Spatial coordinates confirmed.....*

Welcome back to WindyCon! Since we are well aware that no one ever reads this program until they get home, we have prepared for time travelers wishing to return to participate in what surely was/will be a memorable evening.

The Masquerade did/will use adapted International Costumers Guild guidelines for categories and classes. Special steampunk categories are/will be eligible for awards. For specific chronospatial requirements, see the Masquerade table in the hallway somewhere/when. All Competitors must register and have their paperwork completed and turned in at the table no later than 5:00 pm local time.

All individual entries are/will be allotted 1 minute local time, and groups are/will be allotted one minute for the first person and 30 seconds for each additional person. You may provide your own auditory assistance to your presentation by use of Compactical Discii, which should be clearly labeled and submitted with your forms. No matter how advanced your aetheric technology, no costume may compete more than once at the same time.

For those of a less competitive nature, you may wish to consider a stroll along our Clockwork Catwalk as a prelude to viewing the competition. Persons of all stations and styles of dress are welcomed. Persons seeking to perambulate this most adventurous of avenues should register at the Masquerade Table and report to the Viridian Vault (or "Green Room" in the vulgate) no later than 20 minutes before the Masquerade is scheduled to commence.

**Royal STEAMLINE**

*Vintage wedding invitations from a time that never was*

ROYALSTEAMLINE.COM

# Kaja Foglio

## Artist, Writer, Web-Slinger, and Mom

by Alice Bentley

I've known Phil since the mid-1970s, but it wasn't until the early 1990s that tales of Kaja started to percolate through the ether. We heard vague rumors of doings with the Society for Creative Anachronism and fascinating art projects.

Then she and Phil both came to Chicago for Chicon V, the 1991 Worldcon, and Kaja was deluged with all of Phil's Midwest friends at once. She survived the experience with panache, and we were all delighted, but not surprised, when the two of them got married in 1993.

Kaja's career as a professional artist began straight out of college. After graduating from the University of Washington she launched into prominence in the gaming world with *Magic the Gathering*, where she has done the artwork for more than half-a-hundred cards, starting with the *Arabian Nights Expansion*.

You can see some of the breadth of her talent in her eight-page comic "The Cat on the Dovrefjell." Written and penciled by Kaja, and published in Aeon's *Last Dangerous Christmas*, it's a great showcase for an adaptation of a traditional folktale that manages to stay true to tradition while incorporating new elements. But you don't need to take my word for it — she has put the story up at [www.girlgeniusonline.com/stories/dovrefjell/dovrefjell\\_01.php](http://www.girlgeniusonline.com/stories/dovrefjell/dovrefjell_01.php)

The two of us got to know each other a little better in 1998, when I was putting together a reprint edition of Barry Hughart's three fantasy novels, collectively known as *The Chronicles of Master Li and Number Ten Ox*. I knew

from the very first who I wanted for the cover art, but time, projects, and enthusiasm conspired to have her do six full page interiors and all of the incidental art as well.

These days Kaja's excellent storytelling, painting, drawing, and writing are overshadowed by her graphics design chops, as she does all the lettering, final layout, cover designs, and printing prep for *Girl Genius* and other Studio Foglio titles, as well as all the web-wrangling.

It was while she and Phil were searching for a term that summed up the look of *Girl Genius* — which, after all, is not very punk-y and doesn't run just on steam — that Kaja coined the phrase "Gaslamp Fantasy."

The fact that she was already conversant with HTML in 2005 was an important factor in the world-shaking shift of taking *Girl Genius* from quarterly issues in the comic shop to being posted free on the web.

When your day job is making comics, it's a good idea to have some serious fun to unwind with. Just get her started talking about shōjo manga and anime, or the newest version of *Legend of Zelda*, or the latest (or should that be earliest?) steampunk fashions, or the great new craftwork that's in pieces in the studio, and the hours just melt away.

For the Studio as well, the lists of upcoming, ongoing, in progress, and future projects are literally too numerous to list, but I look forward gleefully to whichever one reaches the top of the stack next. So many projects, so little time.



## Artist Guest of Honour

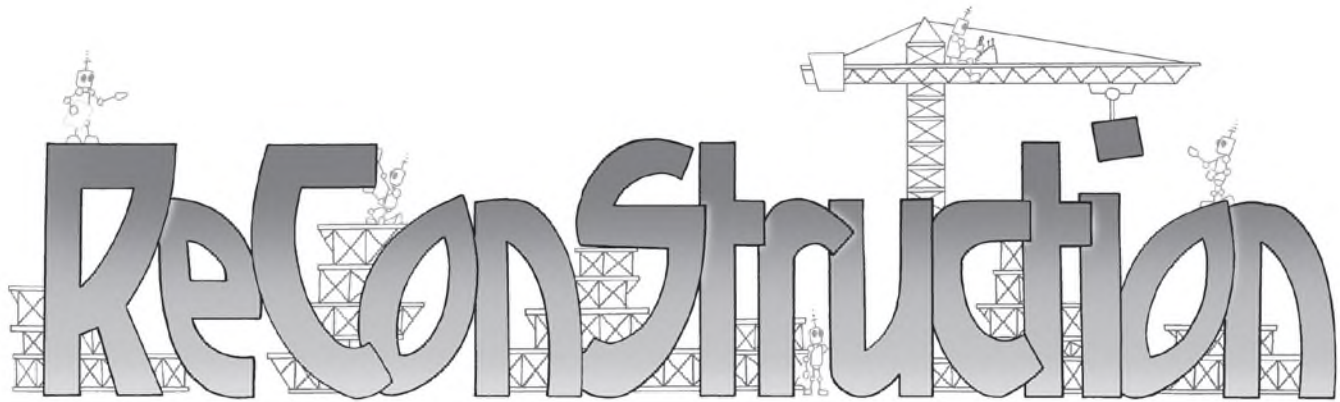

**THE 10<sup>TH</sup> OCCASSIONAL NORTH AMERICAN SCIENCE FICTION CONVENTION**  
**RALEIGH, NORTH CAROLINA • AUGUST 5-8, 2010**

Raleigh Convention Center • Marriott Raleigh City Center • Sheraton Raleigh Hotel

**GUEST OF HONOR - ERIC FLINT**  
 Author of the *Belisarius* and *1632* series  
 Editor of *Best of Jim Baen's Universe*

**ARTIST GUEST OF HONOR - BRAD FOSTER**  
 Six time winner of the Best Fan Artist Hugo  
 Founder of Jabberwocky Graphics

**FAN GUEST OF HONOR - JUANITA COULSON**  
 Filk Hall of Fame inductee  
 Co-Winner of Best Fanzine Hugo (1965) for *Yandro*

**TOASTMASTER - TONI WEISSKOPF**  
 Publisher of Baen Books  
 Winner of the Rebel, Phoenix, and Rubble Awards

ReConStruction will feature:

- |                |                 |                       |
|----------------|-----------------|-----------------------|
| Anime!         | Filk!           | Masquerade!           |
| Art Show!      | Films!          | Panel Discussions!    |
| Con Suite!     | Gaming!         | Southern Hospitality! |
| Dealers' Room! | Kaffeeklatches! | Much more!!!!         |

**MEMBERSHIP RATES THROUGH DECEMBER 31, 2009:**

If you voted in Site Selection:

	Standard Rate	Friend of the Bid	Presupporter
Attending	\$55	Automatic	\$35
Supporting	Automatic	Automatic	Automatic

If you did not vote in Site Selection:

	Standard Rate	Friend of the Bid	Presupporter
Attending	\$95	\$45	\$75
Supporting	\$30	\$10	\$20

[www.reconstructionsf.org](http://www.reconstructionsf.org)  
[info@reconstructionsf.org](mailto:info@reconstructionsf.org)

Mail check or money order to:  
 ReConStruction  
 PO Box 31706  
 Raleigh, NC, 27612

ReConStruction is hosted by the Southern Alliance of Fandom Enthusiasts, Inc. (SAFE), a 501(c)3 nonprofit organization.

"World Science Fiction Society", "WSFS", "World Science Fiction Convention", "Worldcon", "NASFiC", "North American Science Fiction Convention", "Hugo Award", and the distinctive design of the Hugo Award Rocket are service marks of the World Science Fiction Society, an unincorporated literary society.

# TOM SMITH

by Eric Coleman

The world's fastest filker. 13 Pegasus Awards, numerous more nominations. I gave up counting how many conventions he's been a Guest of Honor at around 750 (ok, maybe I exaggerate a little). Political nutjob (I can say that because I happen to agree with pretty much all his politics). Bunches of CDs and even more stuff downloadable from his website. He's a *frakkin'* professional filker!!! You all know this. You've seen Tom. You've been to his shows. You've talked to him in the hall. You've been to his website. You've read his LiveJournal. Who needs to hear this stuff again? Wait, I just wrote it all again. I hate it when that happens.

Ok, I'm a performer too, so being a performer, I need to make this about ME !!! ME !!! ME DO YOU HEAR ME !!! MEEEEEEEE !!!

Sorry, I get carried away, or at least I should be carried away. Anyway, let me talk about my personal experience with Tom Smith.

I met Tom at Archon in 2005. It was my first time (and if anyone has any sense my last time) being a GoH. When Gary Hanak emailed me asking me to be the Filk GoH, my reaction (and this was my reaction, ask Gary) was to say "shouldn't you ask someone who has something more to do with Filk, like say, Tom Smith?" Gary informed me that Tom had already been the GoH at Archon, so I was stuck.

A week or a month or sometime later (time is not one of my strong points) I got an e-mail from Gary. Everything he had scheduled me for, barring my solo concert, was with Tom. Tom sent Gary an e-mail wondering if that was a good idea, he didn't want to take away from my moment. I was the GoH, but he was, well, ya know, Tom Smith (not that he was being pompous or anything, he's not like that, but yeah, I'm this guy, and he's *Tom Smith*). So Gary asked me what I thought. Geeze, it's a no brainer.

The worst case scenario, some of Tom's fans don't like me. Best case scenario, some of Tom's fans like me. I see no problems with this at all.

So I spent much of the weekend sitting next to this force of nature. I have this photo of me looking at him in amazement. I spent a lot of the weekend looking at him in amazement. Tom has that effect on you, especially if you are up there on the stage with him. I put a brave face on it in my LJ, go back and look at the entries in with the Archon tag, but really, I was terrified. How was I going to cope with this? It was simple. He did his thing, I did mine, and we had a great time. And I learned a lot.

I became known as someone who improvises a lot. I wasn't that guy then. And ya know, a lot of reason that I got the reputation was watching and learning from the Master. He's given me advice over the years, but mostly it's been watching him in front of an audience. He improvised an entire half hour show at Marscon a couple of years ago and it was amazing.

I've seen him tear up filk circles with half an idea that someone came up with. I keep looking on in amazement just like I did in that photo from Archon.

Wow, when did this turn into a fan letter? The answer, of course, is as soon as I started writing it.

Tom is one of those folks who are very important to us, to his family, and I never really thought about fandom that way until I heard him say it. And he is a very important part of our family. Why, I'll tell you why ... He's funny, he's cantankerous, he's caring, he's brilliant, he has incredible range, really, he wrote "Operation: Desert Storm" and "A Boy And His Frog," and he's made Dorsai weep. None of the rest of us come close to that.



## *Filk Guest of Honour*

# ART SHOW

## Friday

1:00 pm - 4:00 pm Artist setup only  
 4:00 pm - 9:00 pm Open to WindyCon attendees  
 9:00 pm - 10:00 pm Wine and Cheese Reception.  
 Meet the Artists

## Saturday

10:00 am - 6:30 pm Open to WindyCon attendees  
 12:00 noon Quick Sale opens  
 8:00 pm - ??? Art Auction  
 10:00 pm-ish We will attempt to start art pickup

## Sunday

10:00 am - 2:00 pm Art pickup and artist checkout only  
 Print Shop Open

The Art Show will run a silent auction on Friday and Saturday until 6:30 at which time the Art Show will close to set up for the Art Auction. Pieces with 1 to 3 bids are sold to the high bidder on the sheet. Pieces with 4 or more bids will go to the Art Auction. All charity pieces will be treated just like any other art. They will not go to auction automatically.

WindyCon will be offering Quick Sale again this year. QS opens at Noon on Saturday. There is NO QS on Friday. If there is a QS price on the bid sheet, and no bids have been entered, then you may purchase a piece instantly by finding an Art Show Worker and paying the Quick Sale price for the piece (This is like eBay's Buy It Now). Any art that has a bid entered is NOT available for Quick Sale.

Any art that has SOLD on the bid sheet is not available for bidding on. Only Art Show staff is allowed to remove artwork from the grid or tables. Do NOT take the piece to the checkout desk. We request that artwork stay in the show until checkout time so that others may see it. Early removal of artwork must be cleared through the Art Show Head.

There will be a Fan's Choice award given to the artist who receives the most votes, so please, look around, find the artwork you like the best, and vote! Awards will be given for both 2-D and 3-D artwork, so make sure you look at everything.

The Art Auction will be at 8:00. Our illustrious auctioneer and his crew provide some of the best entertainment at the convention, so come to watch, come to bid, come to have fun, and don't forget your wallet. You never know when something will strike your fancy... or when you will find that perfect gift for someone.

## Print Shop

The Print Shop has been integrated back into the Art Show. If you are looking for art at a fixed price, check out our Print Shop. We have a wide selection of artwork from a variety of talented artists available at prices that won't break the bank. The Print Shop carries more than just prints, so make sure to stop in and look at the calendars, mouse pads, bookmarks and other wonderful works for sale. If you find you have money left after the Art Show closes, the Print Shop will be happy to take it right up until we close at 2:00 on Sunday.

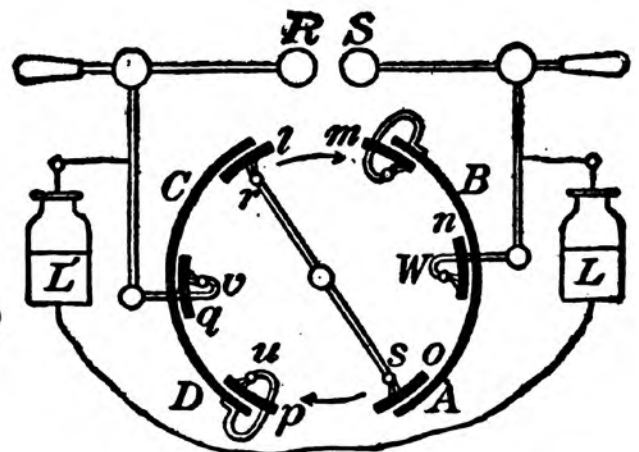
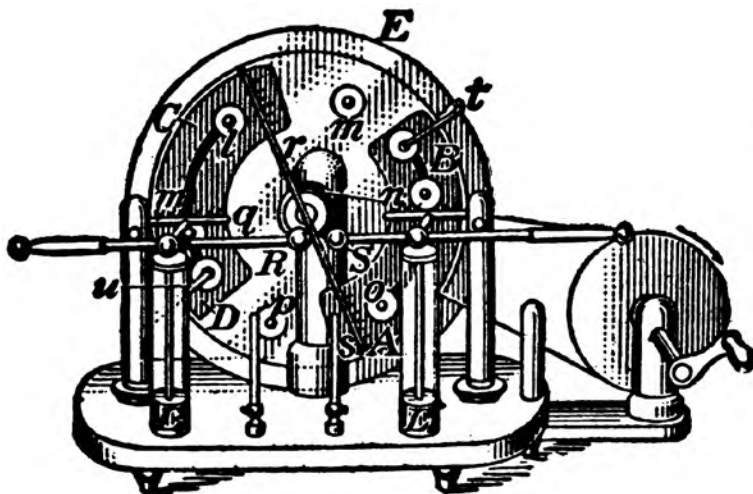

# CHIRIS

# GARCIA

## *(Mid)Night at the Museum*

by Steve Green

The car park was deserted by the time the taxi swung in front of San Jose’s Museum of Computer History. My contact From the Office of Scientific Intelligence was standing in the shadows to the side of the main entrance.

“You took your time,” she growled. I shrugged, watched her key the security code and then we were inside.

“I’ve seen both of those Ben Stiller movies,” I quipped. “So, do the computers come alive at night, plotting the extermination of mankind?”

She turned towards me with a look fit to shatter granite. “I thought you wanted to know the truth about Garcia. The real truth. Don’t blame me if you can’t handle it.”

We walked across the foyer, past the replica of Babbage’s Difference Engine and through an anonymous locked door into what I realised to my surprise was a concealed elevator. The last one of those I’d used had been in the back of a tailor’s shop in Manhattan.

The shaft opened onto a dimly-lit void, but I could just make out two long, wide rows of crates stretching into the gloom. I wonder if this is where they store the Ark of the Covenant, I thought, but wisely kept my mouth shut. I’d spent too long chasing the mystery of Christopher Jophan Garcia to wreck my chances this late in the game.

“Congratulations.” My guide’s tone was as chilled as an Illinois spring. “You’re the first to get this far. What tipped you off?”

“Too many coincidences, for a start. The mysterious fire which allegedly destroyed all records of his birth, the preternaturally swift rise to prominence in the science fiction press, that wild hair...”

She produced a noise which might conceivably have been a stifled laugh. “Yes, especially the beard. The techies reckon

it’s a result of the static electricity the original Garcia passed through on his journey back to 1975.”

Before I had a chance to voice my immediate confusion, a folder was thrust into my hands, the label Project Aspertame borderline-legible in the glow from the elevator.

“The top photograph was taken in Los Angeles, at the very first NASFiC. We estimate his age there at nine months. The next photograph is of the capsule he arrived in.”

“And the guy holding the baby is Johnny Garcia, the OSI operative who adopted him?”

“Once we understood the gravity of the situation — that in the future, science fiction fanzines were a dying form, and that this infant was being sent back through time to keep them alive — we had no choice but to enlist one of our own who, luckily, had already infiltrated Californian fandom. The next fourteen years were spent schooling the visitor in the ways of our century, before he could reappear at the 1989 Timecon.”

“So why wait until 2005 to release his first fanzine?”

“The technology had to catch up. Electronic ‘zines were the future, and the only way he could feasibly distribute so much material on such a tight schedule.”



## *Fan Guest of Honour*

## *A Children's Tale*

Another tale of the crew of the *Brass Griffin*  
From C.B. Ash  
Author of Kinloch and Red Lightning

Down!" Moira shouted before ducking below deck.

A moment later the whine of steam engines turned to an angry buzz. From two long nozzles attached to hoses on the wings erupted blue-white bolts of lightning, guided by streams of high pressure water jets. The electrified stream scoured the deck and snow, tearing a pair of lines into whatever they touched. Nearly singed in the process, Captain Hunter threw himself across the children to protect them. Bits of wood and brass exploded from the wreck and rained down in all directions. Snow vaporized in whitish clouds of fog before it condensed back to snow. Finally the biplanes tore by overhead, passed beyond the wreck and climbed above the trees towards the clouds again.

Hunter eased up slowly, taking deep breaths to steady his voice. He had been shot at countless times when he served in the Royal Navy, but one never grew used to such an experience. Adrenaline tempered his nerves, and after a second breath he looked down at the terrified children.

"Both ok?"

He was rewarded by a pair of nodding, grimy faces drawn with lines of hunger and fear. From the hatch, William's panic-white face peered over the edge and looked skyward. Behind him, O'Fallon had already drawn a pistol and true to his nature, looked for a chance to soothe his anger. Moira however, was not within sight.

"Good, now a brief introduction, I'm Captain Anthony Hunter of the *Brass Griffin* and this is my crew. We're here to help."

Immediately, the children screamed again.

Available for the Amazon Kindle™ or  
Read more at  
<http://www.brassgriffin.com>

I allowed myself a smile. "Which was your first big mistake. Even someone with Howard Hughes' social life and permanent insomnia couldn't match that output: more than two hundred issues of *The Drink Tank*, nearly one hundred issues of *Science Fiction / San Francisco* with Jean Martin, that massive TAFF report he released the moment he got back from the UK. There had to be some kind of production team helping out."

This time her laugh broke free and loud. "You don't know the half of it. The OSI developed bionics back in the 1970s and designed a rudimentary android in 1987. This was a major step up, but preserving fandom is a national priority."

Suddenly, light filled the room and I could see that what I'd mistaken for crates were in fact oblong booths, open at the front — and each containing an identical version of Chris Garcia.

"According to the guys in the lab, there's no problem reproducing his brain, but that beard is a nightmare. They end up weaving them out of wire wool, then using a paint spray developed for Ukrainian fire engines in the 1950s."

"But..." I couldn't believe I was lost for words, but I'd stumbled into unexpected territory. "Why so many?"

"It's not just the fanzines, although at least a dozen Garcias are deployed on keyboard duty at any one time, but we have to support all those convention and party appearances. We needed three just to wander around the Montreal worldcon wearing the TAFF scarf."

"So where's the original?"

"He's at WindyCon this weekend. Goldman believes it's crucial to the timeline."

This was way bigger than I'd realised. No reputable magazine, even a scuzzy tabloid, would publish a story this ludicrous.

Good thing I still had the e-mail address for *Locus*...



# CHRISTIAN READY

by Robert Rede

What can be said about Christian Ready that hasn't already been said? Quite a bit actually, but I should probably stick to the facts for this bio. Chris, my female friends tell me, has the body of a Greek god.

Chris will probably deny this. But when he offered to strip down for a WindyCon charity auction, the amount bid to see his bod by women was only matched by the amount pooled by the men who were afraid having him bare his chest would forever ruin their chances with the women (it wouldn't have...they didn't have a chance, anyway). Chris did this early in his career as a convention goer, but will surely never live it down.

Chris has worked as a scientist for NASA, so you know he isn't just a pretty face. He also has a great sense of humor, so you would think, with all this going for him (plus an attractive wife, who has also published fantasy novels, *Bad to the Bone* and *The Reawakened*), it would be easy to hate him. You'd be wrong. He is one of the nicest guys I know. And friendliest.

Although the stripping incident will forever follow him, Chris continues to help out at the charity auctions. Trained by Dr. Bob Passovoy, he is highly entertaining when he calls for bids, one time even auctioning off a painting to someone who wasn't at the convention but who happened to call a bidder in the middle of the

auction. Chris took the phone from the attendee's hand and proceeded to drive up the bidding until the absentee bidder had bought the painting, sight unseen.



## *Toastmaster*

Chris packs the room to overflowing when he pulls out his slides taken by the Hubble Space Telescope, so make sure you arrive early, otherwise you'll be standing in the hallway trying to see over the brow ridges of a seven foot tall Klingon.

While Chris is more than willing to talk about NASA and space exploration, if you really want to get him started, ask him about one of his latest interests...the Civil Air Patrol. Major Ready, the commander of the Carroll Composite Squadron was presented with the Commander of the Year Award in 2004. Shortly after receiving the award, he accepted the position of deputy commander for Maryland Wing's Group Two.

The attendees at WindyCon are lucky to have Chris at the con. He adds class, intelligence and wit to any assemblage (although I'm sure he's blushing to read this). So, go hear him talk about space, hope he's part of the auction entertainment, try to corner him for a talk as he glad-hands his way around the Westin, and if he offers to sit down to play poker with you, take him up on it. After all, the con-com isn't paying him to be here and he can use your money.

# KIDS PROGRAMMING

Hospitality Suite - Room 232

## Upcoming @ Windycon

### READING GROUP

Saturday: afternoon  
*The Difference Engine*  
Sterling & Gibson

## Dark City Shell Beach Express

Saturday @ 9PM we'll  
throw our annual party,  
this year honoring the  
Alex Proyas classic.

## Around Chicagoland

### MONTHLY SOCIAL

December 1 @ 7:30PM  
Dave & Buster's  
1030 N Clark

### READING GROUP

December 19 @ 2PM  
Oak Park Public Library  
Reading: TBD

### PIZZA

Fans test pizza places  
December 8 @ 7:30PM  
Albano's Pizzeria  
5913 W Roosevelt Cicero

### BOWLING

Monthly fannish bowling  
Coordinates: TBD

### AVATAR--IMAX 3D

James Cameron is back!  
December 18 ???  
Navy Pier

[www.chicago-sf.org](http://www.chicago-sf.org)  
[council@chicago-sf.org](mailto:council@chicago-sf.org)  
FANS HAVING FUN  
JOIN US

## FRIDAY

6:00

### Bead-O-Rama

Decorate your badge holder or make some jewelry for yourself or friends.

7:00

### Movie and Munchies

Come watch *Treasure Planet* with your friends to get in the steampunk spirit.

## SATURDAY

10:00

### Kids Costuming

Make a costume to wear for the weekend or to highlight in the Masquerade

12:00

### Balloon Twisting

Our Crazy Balloonatic, John Wardale, will be making balloon sculptures including hats, devices, animals, and aliens. Requests will be taken. 2 page menu of choices also available. Be forewarned: LATEX products will be in use.

1:00

### LUNCH

Kids' programming will be CLOSED during this hour and parents are responsible for retrieving their children for lunch.

2:00

### KookieKlatch

Listen to some stories by guest readers while enjoying cookies with your friends

3:00

### Tied In Knots

Learn knotting techniques and how to make a bracelet with just a piece of rope. Renowned knotwork artist, Loren Damewood, will lead a knot tying workshop for children ages 7 and up.

4:00

### Kids Gaming

*Apples to Apples*, *Blokus* and TONS of other games will be available for you to play with your friends.

## SUNDAY

10:00

### Lego® Mania

Help us build the traditional WALL O' BLOCKS or just be creative with the Legos provided. Led by Beth Weis, the Lego Lady.

12:00

### LUNCH

Kids' programming will be CLOSED during this hour and parents are responsible for retrieving their children for lunch.

1:00

### Trivia for Chocolate

### KIDS STYLE

Test your knowledge of Kid's Movies and Literature. THIS IS FOR THE KIDS NOT ADULTS

2:00

### SciFiFantasy Pictionary®

Play this picture drawing game with subjects based on Sci Fi and Fantasy TV, movies, and books

# PROGRAMMING

Updates and changes to Programming can be found at our Information Desk, just off of the lobby. You can also follow our updates online at *twitter* (@windy36), *facebook* (windycon), and *LiveJournal* (windycon)

## FRIDAY

**4:00**

### Clacks & Clanks

There is a tendency among writers to have steampunk technology copy machines we have today, but does this weaken the uniqueness of steampunk? Panelists discuss how to make your world's technology unique.

*D. Murphy, J. Rovner, P. Ruiz,  
D. Smith, H. Spencer*

**Junior Ballroom B**

### Found Materials

Is it a handful of plumbing parts or the makings of a Heisenberg Aetheric Compensator? Can you build a crossbow from the bins at your local Goodwill? And just where can one find parts to repair one's Backpack Time Machine? Our panelists and audience will share their favourite and most unexpected sources for costume and prop materials.

*J. Ballard-Smoot, B. Dunbar,  
M. Dashwood, L. Lombardi*

**Lilac A**

**5:00**

### Appointment With the End of the World

2012, the end of the world according to the Mayan calendar, is fast approaching. Will it really end this time? What fascinates us with predictions of the end and what do they really mean? Our panelists discuss apocalypses of various types.

*L. Godfrey, E. Maksym,  
B. Thomasson, G. Wolfe*

**Junior Ballroom B**

### Today in Atlantean History

What if Atlantis hadn't sunk? What would have happened to it and us? How would our history have been different if such an advanced civilization had survived?

*L. Dombrowski, J. Nye,  
P. Sayre McCoy*

**Lilac A**

### So, What Is Steampunk?

What makes steampunk steampunk? Is it the Victorian setting, the gadgets? The characters? Our panelists will tell you.

*T. Akers, J. Ballard-Smoot,  
R. Garfinkle*

**Junior Ballroom A**

### Reading

*D. Bingle*  
**Walnut**

**6:00**

### "I Could Kill You With My Mind"

Says River from *Firefly* but she doesn't. Of all the characters on the show, she's the most atheistic, so it's not a religious morality she follows. What is it? What kind of moral philosophy do characters like River follow? Join our panelists and see.

*F. Gehm, J. Helpers, K-E Kelly,  
R. Martinek, J. Robertson*

**Junior Ballroom B:**

### Technobabble Quiz

Quizmaster Steven Silver challenges the panel, and the audience, to apply their knowledge of pop culture and esoterica as well as their ability to think on their feet, or chairs.

*C. Garcia, J. Nye, N. Rest,  
S. Silver, T. Smith*

**Lilac A**

**7:00**

### Opening Ceremonies

Get a chance to meet our guests and get an introduction to what's happening this weekend

**Lilac BD**

**7:30**

### Revenge of the Weasel Queen

A special audio-visual presentation from our Artist Guests of Honor.

*K. Foglio, P. Foglio*

**Lilac BD**

**8:30**

### Hubble Space Telescope: The Final Service Mission and New Observations

Hubble's last servicing mission was this past May and the old telescope has new life. Join Christian Ready for a new show from Hubble (including the comet strike on Jupiter) and find out about Hubble's future.

*C. Ready*

**Lilac BD**

**9:00**

### Wine and Cheese Reception.

Meet the artists in this after-hours social event.

**Art Show**

**9:30**

### TomBoat Concert

Filk GoH Tom Smith plays his most rockin' compositions, backed up by the band Toyboat who will try to keep up. They'll start at 9:30, but who knows when they'll get tired and put down the instruments.

*Tom Smith, Toyboat*

**Junior Ballroom A**

**??:00**

### Open Filk

To begin after Tom Smith and Toyboat are done rocking the house.

**Junior Ballroom A**



30 August – 3 September 2012

They came to Chicago to see the aliens. What they got was something more spectacular than their wildest dreams. Before they knew it, they found themselves in the middle of a full-fledged Worldcon with no way, or desire, to escape until it had run its full five days.

You, too, are invited to help make this adventure a reality, simply by joining the Chicago in 2012 Worldcon Bid.

The Chicago in 2012 bid draws on the city's long tradition of science fiction, from the variety of pulps that were published here (including *Adventure*, *Amazing*, *Fantastic Adventures*, and more) to the artists and illustrators who have called Chicago home.

Chicago in 2012 promises to be a celebration of the future the pulps promised us, and the past that brought that future to us.

Help make that future come true

Join the Chicago in 2012 Worldcon bid

Hosting a Worldcon under one roof at the renovated Hyatt Regency Chicago, just steps from the Magnificent Mile

Chicago Worldcon Bid  
PO Box 13  
Skokie, IL 60076  
[info@chicagoin2012.org](mailto:info@chicagoin2012.org)

Bid Committee: Dave McCarty (Chairman), Helen Montgomery (Secretary), Tom Veal (Treasurer), Gary Blog, Raymond Cyrus, Donald Eastlake III, Jill Eastlake, Catherine FitzSimmons, Lisa Garrison-Ragsdale, Elizabeth Gilio, Michael Kelly, Dina Krause, George Krause, Sydnie Krause, Sandra Levy, Ron Oakes, Tara Oakes, Matthew Ragsdale, Michelle Rhoades, Marah Searle-Kovacevic, Steven H Silver, Bill Thomasson, Barbara Van Tilburg, Ray Van Tilburg, Leane Verhulst, Alex von Thorn.

“Worldcon,” “WSFS,” “World Science Fiction Convention,” and “World Science Fiction Society” are service marks of the World Science Fiction Society, an unincorporated literary society.

# SATURDAY PROGRAMMING 10:00 – 12:00

## SATURDAY

10:00

### Types and Tropes

But I don't WANNA be an airship pirate! Well, how about a Lady Explorer, an Outlaw Alchemist, a Wrench Wench, or a Cryptozoologist? We'll take a look at the "standard" characters plus explore some new options to steampunk yourself.

*B. Dunbar, A. Egan, M. Dashwood, J. Hellum*

**Junior Ballroom B**

### Baen is for Men, DAW is for Women

Looking at the publishing lists of various publishers you can get the impression that they see their niche as one-sex only. Baen, bastion of military SF is definitely for guys, and DAW — well that's girl stuff. Is this true or a misunderstanding of what these publishers are about?

*E. Flint, J. Hines, K. Hughes, M.Z. Williamson*

**Lilac A**

### Non-genre Authors

#### Who Write Genre-Like Fiction

Some authors who may not be immediately identifiable as SF often write SF-like stuff. You should know about them too, so join our panelists and find out what's on the other shelves in the bookstore.

*T. Bogolub, P. Eisenstein, R. Horton, E. Hull, S. Silver*

**Junior Ballroom A**

### Steampunk and Magic

Mixing the magic and the mechanical, Steampunk is more than just gears. Unlike other types of SF, steampunk doesn't separate them into opposing worldviews, but blends them and mixes them. Does this take the mechanical or magical development in different directions than more conventional sf?

*J. Blaylock, D. Murphy, F. Murray*

**Lilac C**

### Reading

*T. Akers*

**Walnut**

11:00

### Getting Worlds Right

You have a map, a river, and some mountains. Think that's enough planning for your world? No way. Think about weather, growing seasons, and migratory animals. Our panelists discuss who got it right and who missed it in their favorite books, films, etc.

*M. D'Ambrosio, J. Helfers, P.C. Hodgell, R. Martinek, J. Smith-Ready*

**Junior Ballroom B**

### Doing the Science in Steampunk

Steampunk is fictional and made for outlandish inventions and plots, but the basics of science still have to be there (aside from hollow worlds or a couple of dinosaurs). How do you get the science right if you're not a scientist?

*D. Cozort, R. Garfinkle, E. Maksym, D. Murphy, P. O'Connor*

**Lilac A**

### Foreign Authors You Should Know

Not just SF, but authors in general from non-English-speaking countries. They have a lot to tell us about their culture and thoughts, so join our panelists to find out who's good and who's great.

*E. Hull, F. Pohl, P. Ruiz*

**Junior Ballroom A**

### Reading

*P. Eisenstein*

**Lilac C**

### Reading

*M. Resnick*

**Walnut**

### Autographings

*J. Blaylock, T. Clemmons, E. Flint*

**Hallway**

12:00

### "With a Little Help From my Friends"

With the economy the way it is, everyone wants to save money as much as possible. Some suggestions that advisors make is to do more work yourself that you used to pay others to do and barter your skills for theirs. But how do you do this? How do you change your own oil in your car or fix your old, leaky faucet? What skills are bartarable?

*V. Hoski, M. Thomas, N. Rest, L. Zeldes*

**Lilac BD**

### Roots of Steampunk

Panelists discuss the masters of Victorian adventure literature such as Verne, Haggard, Wells, and their successors such as Burroughs.

*J. Blaylock, B. Dunbar, C. Garcia, E.E. Knight*

**Junior Ballroom B**

### Saving Our Hero

Based on suggestions from the audience, our panelists devise extraordinary escapes for Our Hero/ine. Think up some really good ones to test our would-be James Bonds.

*T. Bogolub, B. Fawcett, P.C. Hodgell, J. Nye*

**Lilac A**

### My Favourite Things

Stuff you never thought you needed to make things you never knew you could.

*T. Foust, K-E Kelly, R. O'Connor-Rose*

**Junior Ballroom A**

### Lady Adventurers

Although the Victorian ideal of women was frail and helpless, women like Gertrude Bell, played a significant role in the development of the modern Middle East. How did they do it?

*L. Dombrowski, C. Gerrib, R. Karp, D. Kuczwaro*

**Lilac C**

### Reading

*T. Clemmons*

**Walnut**

# GAMING

## **Ballroom J**

Gaming will begin around 6:00 Friday evening, we'll be doing lightning setups to get rolling, until whenever we all die. If it isn't 24 hours then we'll re-open around 9:00-10:00 the following morning.

We'd like to stress that this year we're going to try to keep our voices down so that other players might enjoy their experiences while getting used to everyone being all in one room again.

As usual, members who are gaming are to be reminded that badges are needed, if we can't see it outright, expect to be asked for it.

Several games are going to be there.

- Classic Battle Tech
- Dragonstorm Demos

## **Gozer Games: Collateral Damage**

You take the role of a gang boss trying to take over Neo Japan. You command a group of typical characters from romantic comedy anime. You can direct them to battle it out in a city, but watch out! Characters can fall in love, and may then ignore your orders and instead follow their love across the board, battling it out for their love's affection.

All final times & updates will be posted outside of gaming.

## COMPUTER GAMING

### **Boardroom**

<b>Friday</b>	8:00 pm - 2:00 am	All ages
<b>Saturday</b>	11:00 am - 1:00 pm	Kids games only
	1:00 pm - 2:00 am	All ages
<b>Sunday</b>	11:00 am - 1:00 pm	Kids games only,
	1:00 pm - 3:00 pm	All ages

Note: We will not be monitoring what games the kids are playing during the all ages hours.

# SPECIAL EVENTS

We're looking forward to a lot of fun at WindyCon this year. Start at Opening Ceremonies at 7:00 pm on Friday where you'll get a chance to meet our guests and get an introduction to what's happening this weekend.

Right after that, at 7:30 pm, we'll be bringing you a special audio-visual presentation from our Artist Guests of Honor Phil and Kaja Foglio's *Girl Genius* with "Revenge of the Weasel Queen."

At 8:30 pm, our Toastmaster Christian Ready will make the first of several presentations of photographs from the Hubble Space Telescope. If you've seen Christian before, you know what to expect. If not, you're in for a new treat. Each presentation is different, so you'll want to see them all.

Then at 9:30 pm you can head over to the Filk Room to hear our Filk Guest of Honor Tom Smith singing some of our favorite songs in a unique performance as he'll be backed up by Toyboat's heavy rock sound. You may have heard Tom before, but you've never heard him like this!

On Saturday, you can catch our Masquerade at 8:00 pm. You'll find more information about that elsewhere. And after our costumers strut their stuff, you'll be entertained while you wait for the 9:45 pm Masquerade award ceremony by as many of Tom's songs as he can squeeze into the time available. Did we mention that he's the World's Fastest Filker?

At 10:00 pm, we'll have our Steampunk Dance. Come on down, in costume or not, and dance the night away!

On Sunday, we'll have the Zeppelin Races starting at 11:00 pm. You can bring your own vessel (either rigid or soft-framed) or use one of ours. But it's not just a simple race. You'll want to rig a rescue hook on your zeppelin, because your mission is to rescue a stranded balloon by hooking the attached ribbon loop and towing it to the finish line. It's harder than it looks!

Finally, at 2:00 pm, come by Closing Ceremonies where you can say goodbye to our guests, find out who won what during the course of the con, and learn a bit about what we've got planned for 2010.

# SATURDAY PROGRAMMING 12:00 – 3:00

## Autographing

*L. Godfrey, R. Green*  
**Hallway**

## ISFiC Board Meeting

The annual ISFiC Board meeting is open to all. If you're a member of WindyCon, you're a member of ISFiC.  
**ISFiC Suite**

## 1:00

### What Else is Out There

Hubble isn't the only telescope aiding in our understanding of space. Join Christian and see what has been discovered with the aid of other fantastic scopes.

*C. Ready*  
**Lilac BD**

### Writer Support

Writing can be isolating and it helps to talk it over with someone and get critiques and suggestions. Aside from cons, what's available for writer support these days? Learn about organizations, publications, and online communities that offer this assistance. And watch out for sharks!

*D. Bingle, R. Chwedyc, K. Hughes, M. Resnick, J. Smith-Ready*  
**Junior Ballroom B**

### Mystery Animals

Bigfoot, Yetis, African dinosaurs, and Nessie. Is it possible they're real? Could large animals like this still exist somewhere and if so, why are they so darn hard to find?

*D. Cozort, M. D'Ambrosio, L. Dombrowski, L. Godfrey, R. Jakupovic*  
**Junior Ballroom A**

### Amy McNally Concert

Amy has rapidly become one of the most sought-after accompanists and "accent players" in the Midwest, but she seldom gets a chance to show off her solo violin work. We're giving her that opportunity.

*A. McNally*  
**Lilac C**

## Reading

*R. Green*  
**Walnut**

## Autographings

*P. Eisenstein, J. Helfers, E.E. Knight, J.L. Nye*  
**Hallway**

## 2:00

### My Life in Comics

Join our Artist GoHs in a panel about their development of online comics, their love of the genre of comics/graphic novels in general, and find out what's next for the creators of *Girl Genius*.

*K. Foglio, P. Foglio*  
**Lilac BD**

### Physics of the Impossible: Time Travel

Based on the latest research, panelists discuss the possibility of time travel and what would really be involved.

*T. Clemmons, P. Ruiz, S. Waitsman, A. Woolard*  
**Junior Ballroom B**

### Beyond the Con

Chicago is full of non-con activities: dining, tourism, kids' stuff. Our panelists tell you their favourites.

*B. Miskelley, D. Smith, D. Kuczwarra, M. Lyn-Waitsman, L. Zeldes*  
**Lilac A**

### Distressing Your Damsel

Real Airship Pirates get dirty! We'll discuss various methods of "distressing" clothing and props to get that real "knocked-about-the-Empire" effect.

*J. Ballard-Smoot, S. Edmonds, L. Lombardi, R O'Connor-Rose*  
**Junior Ballroom A**

### Great Luke Ski Concert

With his array of parody and funny music in a variety of styles, Luke is sure to keep you guessing - and laughing!

*L. Sienkowski*  
**Lilac C**

## Reading

*T. Trumpinski*  
**Walnut**

## Phandemonium Book Club

Phandemonium, the club that brings you Capricorn, holds its regularly scheduled book discussion at WindyCon. This year, they discuss the Hugo-award winning novel *The Graveyard Book*, by Neil Gaiman. Hear what other readers like you have to say about it.

**ISFiC Suite**

## Autographings

*T. Akers J. Hines, P.C. Hodgell*  
**Hallway**

## 3:00

### Non-verbal Communication

If you don't have a mouth, how do you talk? If you live in a vacuum, how do you hear? If the octopus suddenly turns black is that good or bad for you? New species have new ways of communicating and our panelists will tell you all about them.

*D. Murphy, J. Nye, P. Sayre McCoy, M. Thomas*

**Junior Ballroom B**

### The New Weird

No need to ask if it's really weird, but is it really new? Is this the same stuff that was always hiding around the corners, but with genetic recombination added?

*T. Akers, F. Gehm, K. Hughes, A. Woolard*  
**Lilac A**

### Concert

*Tom Smith*  
**Junior Ballroom A**

### Saturday Afternoon at the Movies

Remember those old TV movies — Tarzan, John Wayne? Why do we remember them so fondly? Reminisce with our panelists for awhile.

*R. Chwedyc, M. D'Ambrosio, S. Waitsman*  
**Lilac C**

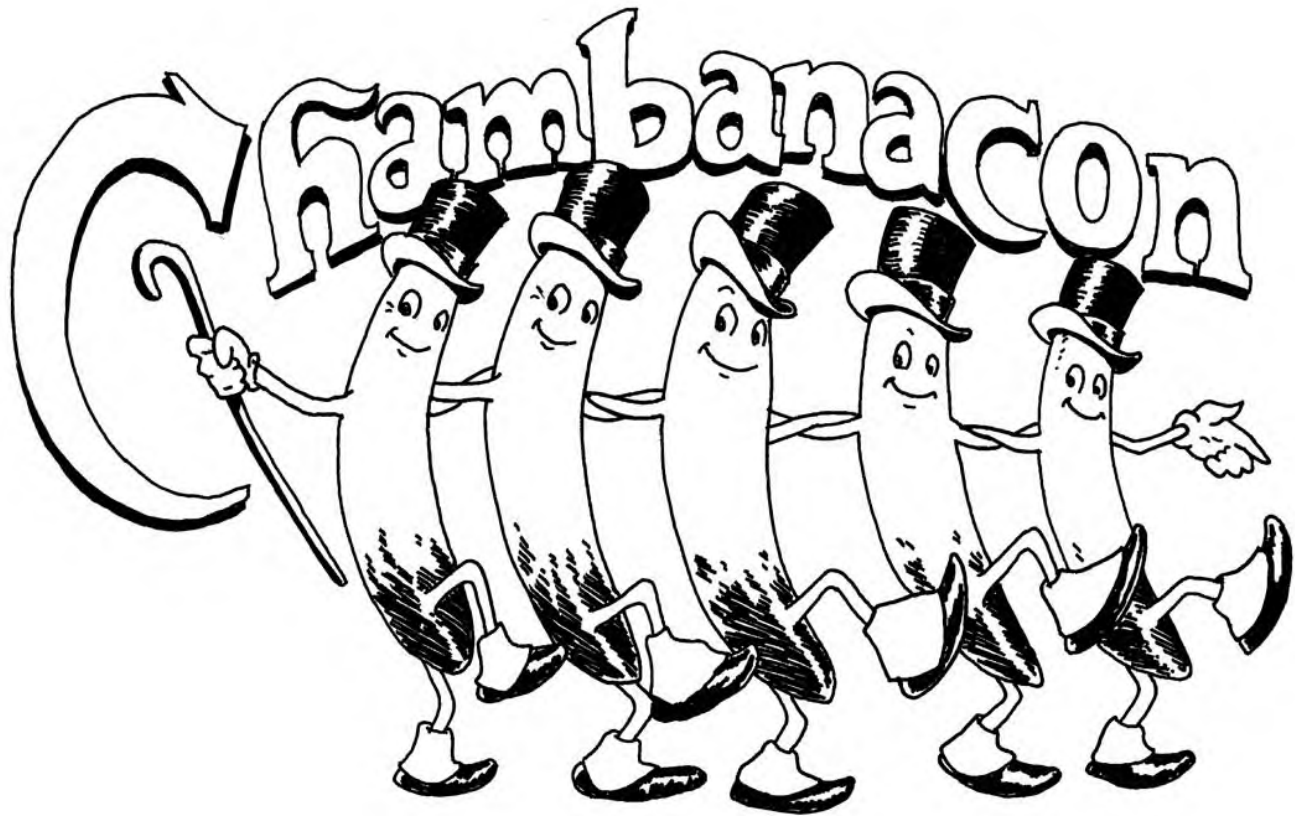

The longest running relaxacon\* in IL

# ChamBanaCon 39

November 27 – 29, 2009

In Springfield, IL at the

Route 66 Hotel and Convention Center!

**Guests of Honor:**  
**Author: Eric Flint**  
**Fan: Brenda Sutton**  
**Toast: Bill Sutton**

Visit our web site at [www.chambanacon.org](http://www.chambanacon.org) for more info!

---

\* SMOFing, Sleeping, SMOFing, Eating, SMOFing, Filking, SMOFing, Relaxing, and – did we mention: SMOFing!



# SATURDAY PROGRAMMING 3:00 – 10:00

## Chris Garcia Talks

In which our fan GoH explains why “*Dude, Where’s My Car*” is, in fact, a Sci Fi film (it does have the words “continuum transfunctioner” in it) and why it is awesome. See the film at 2:00 and stay after to hear his point and agree or disagree.

*C. Garcia*

**Film Room**

## Book Discussion

*chicago-sf.org*

**ISFiC Suite**

**4:00**

## Parts is Parts

Led by our intrepid inventors, participants will create their own steampunk creations from whatever we find in the box of parts. Audience participation is pretty much required, as are donations of “stuff.”

*A. Egan, T. Foust, W. Zdrodowski*

**Lilac A**

## That’s Our Girl

Phil and Kaja Foglio have spent considerable amounts of time protecting their intellectual property rights to *Girl Genius* and have successfully kept a hold of her. That’s not as easy as it sounds and copyrights and intellectual rights, particularly those regarding electronic works, change frequently. Phil and Kaja discuss their experiences protecting their IP rights and offer insights for anyone else considering creating their own online business.

*K. Foglio, P. Foglio*

**Lilac BD**

## Fandom Looks Back

Older fans look back at what got them into fandom and how it has changed. We look at what we got out of it and what we’re still getting today.

*K-E. Kelly, M. Lyn-Waitsman,*

*D. Smith, B. Thomasson, L. Zeldes*

**Junior Ballroom B**

## Dystopia Begone

Does the future have to be so grim? Is our future really overcrowded, polluted and unequal? What books are interesting, good to read, and have a positive view of the near future? Or is there a positive view? Our panelists discuss the world of the next 100 years.

*E.E. Knight, J. Plaxco,*

*M.Z. Williamson, G. Wolfe*

**Junior Ballroom A**

## Africa in SF

Steampunk seems tailor-made for African themes of lost civilizations and strange beasts, but what about other speculative fiction genres? Is there African SF? Is there fantasy based on African mythology and folklore? Our panelists will tell you.

*D. Cozort, E. Flint, D. Mead, F. Murray,*

*M. Resnick*

**Lilac C**

## USS Magellan Meeting

New Star Trek club. Open meeting.

**ISFiC Suite**

## Reading

*S. Silver*

**Walnut**

**5:00**

## Free Books

In a tight economy, fans need to save money on everything. How do we manage a limited budget and still get new SF? Our panelists let you in on all the sources for free books and stories.

*E. Flint, J. Rovner, S. Silver,*

*B. Trumpinski-Roberts*

**Junior Ballroom B**

## Lost Worlds Beyond Atlantis

There’s more than one lost continent out there and our panelists will tell you all about them.

*B. Fawcett, E.E.Knight,*

*E. Maksym, M. Resnick*

**Junior Ballroom A**

## The Victorian Adventurer

### Through the Ages

Panelists look at the adventure heroes though time from the Man Who Would be King to Flashman and beyond.

*P.C. Hodgell, N. Rest, S. Waitsman*

**Lilac BD**

## Reading

*J. Smith-Ready*

**Walnut**

**6:00**

## Chicago 2012

Chicago’s Worldcon bid information and fun. We blew the Olympics and never had a chance at the World Series; let’s get Worldcon. Everyone welcome.

**ISFiC Suite**

**8:00**

## Masquerade

Check out the latest in steampunk fashion, as well as a host of other costuming creations.

**Lilac AC**

**9:00**

## ISFiC Press Launch Party

ISFiC Press launches its eighth book, *The Shadow on the Doorstep* on Saturday in the ISFiC Suite. Join us for refreshments and the chance to buy this book (or previous releases, complete your collection) and get the book autographed. All currently available books will be for sale at the launch party as well as in the dealers’ room.

*J. Blaylock, K. Foglio,*

*P. Foglio, S. Silver*

**ISFiC Suite**

## Open Filking

**Junior Ballroom A**

**10:00**

## Steampunk Dance

Come on down, in costume or not, and dance the night away!

**Lilac AC**

# THE CLOCK AND MIRROR

## CON SUITE

### Friday

11:00 am	- 12:00 noon	Staff and Merchants only.
12:00 noon	- 3:30 am	All Travelers with Con Badge
3:00 pm	- 3:00 am	Bheer Available (ID Required)

### Saturday

9:00 am	- 9:30 am	Staff and Merchants only.
9:30 am	- 3:30 am	All Travelers with Con Badge
3:00 pm	- 3:00 am	Bheer Available (ID Required)

### Sunday

10:00 am	- 10:30 am	Staff and Merchants only.
10:30 am	- 3:00 pm	All Travelers with Con Badge
12:00 noon	- 2:00 pm	Bheer Available (ID Required)

## *Fine Victuals for the Discerning Traveller*

Proprietors Master Brent Warren and Mistress Saeri Geller bid all travelers welcome to their well-provisioned eating-house, along with Alemaster Andrew Scheeler, overseer of a most impressive selection of first-rate brews for your drinking pleasure.

Due to the exclusive nature of our public house, we remain duty-bound to admit only patrons displaying a badge in connection with the Convention of Windy, number six and thirty, held this year of two thousand and nine. In addition, any who wish to partake of any alcoholic Beverages offered by the Alemaster, such as bheer, must carry an identification card issued by the government, such as a Driver's License or a State ID, that proves to us that you are at least twenty-one years of age.

For the convenience of the convention staff and merchants (Dealers), the Clock and Mirror will open early each morning, as shown by the Hours of Operation listed above.

## *Frequent Queries*

### *How do I gain admittance to the Clock and Mirror?*

To enter before hours, you must have proper identification. A convention badge that proves you are a merchant or staff member is sufficient and we will check all badges at the door.

For all remaining patrons wishing to partake of our edibles during the designated times, a convention badge is all that is required to gain entrance into the parlor. We will have a door-minder at the entrance during open hours to confirm you have the appropriate papers.

### *What sorts of refreshment can we expect to find?*

In addition to the bheer and hard cider that are available during happy hour, we offer a variety of savoury snacks, cookies, and other sweet things at all times, as well as sliced bread, pureed peanut spread and fruit jam. During those times that one might appropriately eat a full meal, we will offer more filling types of food, such as we can serve at the inn without trespassing on any of their rules.

## *Rules of the Establishment*

1. Patrons' convention badges displayed on their person at all times is a requirement.
2. The smoking of cigarettes, cigars, cigarillos, pipes, hookahs, and the use of snuff, or any other tobacco or dried-leaf-based instrument is absolutely forbidden within the Clock and Mirror as well as within the Westin Inn itself. Should one wish to take part in such things, a smoking area has been designated outside the entrance to the lodging house (the Westin).
3. All RED CUPS, which are to be exclusive vessels for bheer, are prohibited outside of the saloon.
4. Those who wish to imbibe any alcoholic concoctions will be required to not only show the door-minder your convention badge, but you must also have your genuine, government-issued Driver's License or State ID. This is to confirm that you are, indeed, the actual person identified on the back of your convention badge, as well as at least twenty-one years of age.
5. Despite the fine quality of the refreshments served at the Clock and Mirror, it is the patrons who are required to keep the area in which they take their pleasure tidy and clean, being that their mothers do not reside here and will not clean up after them. Appropriate vessels have been placed conveniently to assist patrons in their duty.

*Addendum:* Though a patron have a hand-stamp, proprietors may still request to see your local government-issued Driver's License or State ID, in the event a patron should wish to drink alcoholic beverages.

*Second Addendum:* Proprietors reserve the right to add further rules as needed and will not hesitate to remove a patron's convention identification papers if necessary.

# SUNDAY PROGRAMMING 10:00 – 11:00

## SUNDAY

10:00

### Don't Lick the Wallpaper - Color and the Victorians

The Victorian world wasn't painted in drab sepia tones. With the invention of artificial colors they lived in a world of vivid purples, magentas, and other bright colors. There was a pretty good chance that some of them could kill you, but that's all part of Scientific Progress. *K. Bergquist Dezoma, A. Egan, J. Hellum, W. Zdrodowski*  
**Lilac BD**

### "My Cell Phone Was SF in 1950, but now..."

We don't have our flying cars, yet, but many common everyday items we use now were once SF. Panelists discuss inventions in SF that are now in everyday use and how they are the same or different from what was imagined. *P. Eisenstein, H. Spencer, B. Thomasson, L. Waitsman, A. Woolard*  
**Junior Ballroom B**

### Ooh Shiny! Metalworking 101

Brass and copper and steel... Oh My! Patrick will share some techniques to help you get started with these intimidating but rewarding materials. *P. O'Connor*  
**Lilac A**

### Rowling and Meyer

What are our kids reading now? Is there truly a young adult revival of speculative fiction or are these anomalies? Are our kids reading more SF or still playing it on the Wii™? *M. Haskell, J. Hines, R. Neumeier, J. Smith-Ready*  
**Lilac C**

### Reading

*P.C. Hodgell*  
**Walnut**

### Autographings

*D. Bingle, M. D'Ambrosio, K. Hughes, S. Silver*  
**Hallway**

11:00

### Trivia (Chocolate) for Chocolate (Trivia)

Steven Silver presents the popular "throw candy at 'em" game show, where audience members guess the answers to SF trivia in return for chocolate. The one with the most candy wins — wrappers don't count, so if you ate it before the game was over, hope it was good! *E. Silver, M. Silver, R. Silver, S. Silver*  
**Lilac A**

### Universal Tour

Christian takes a picture show through the solar system with all the newest photos. *C. Ready*  
**Lilac BD**

### Zeppelin Races

You can bring your own vessel or use one of ours. Your mission is to rescue a stranded balloon and tow it to the finish line. It's harder than it looks!  
**Junior Ballroom A**

### Court of the Crimson Kings

Good old adventure SF. Space opera, exotic alien cultures. What else is out there like this? Was John Carter the last romantic hero? *R. Horton, F. Pohl, P. Sayre McCoy, G. Wolfe*  
**Junior Ballroom B**

### "Your Girlfriend is a What!?"

Alien partners in SF are common in many stories and movies, but how does this really work? Aside from not breathing the same atmosphere or eating the same foods, how do you introduce them to your family? What will you name the kids? *F. Gehm, F. Murray, T. Trumpinski, L. Waitsman*  
**Lilac C**

### Victorian Crochet

While away the time in your Zeppelin with this most portable of domestic arts. Melora will teach a simple Victorian crochet pattern. We will have a limited amount of yarn and hooks available or you can bring your own. *M. Dashwood*  
**Walnut**

### Autographings

*M. Resnick, J. Smith-Ready*  
**Hallway**

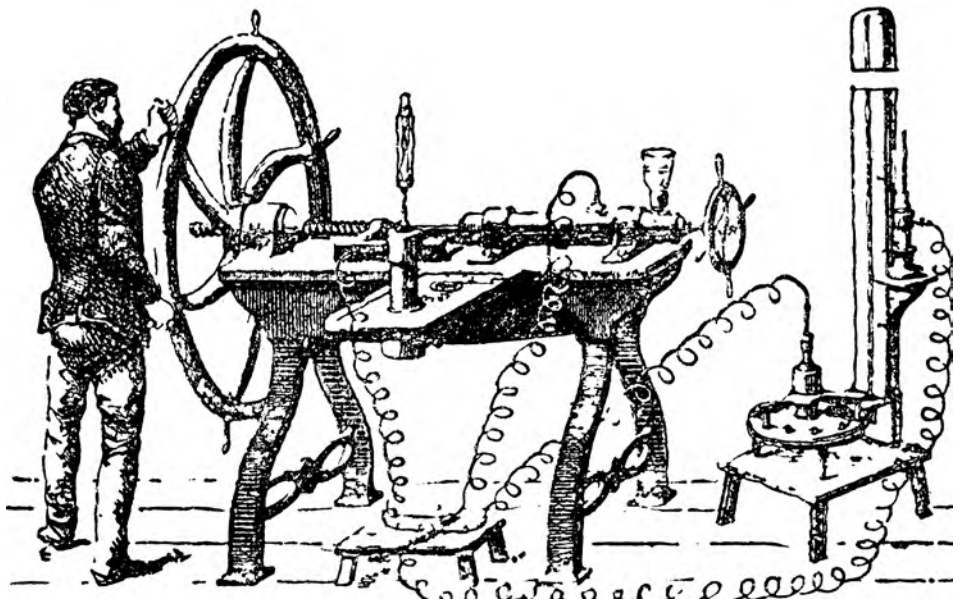



FEBRUARY 11—14, 2010  
BOOKS! PANELS! FILM! MOVIES! CHICAGO'S BEST CONSUITE!  
ANIME! GAMING! PARTIES!

AUTHOR GUESTS OF HONOR  
FREDERIK POHL—SPIDER AND JEANNE ROBINSON—ROBERT J. SAWYER

ARTIST GUEST OF HONOR  
LUCY SYNK

FAN GUEST OF HONOR  
ALICE BENTLEY

LOCATION / HOTEL  
WESTIN CHICAGO NORTH SHORE  
601 N. MILWAUKEE AVENUE  
WHEELING, IL 60090  
(847) 777-6500  
[WWW.WESTINNORTHSHORE.COM](http://WWW.WESTINNORTHSHORE.COM)

ROOM RATES  
REGULAR ROOM (QUEEN/QUEEN OR KING): \$103.00 / NIGHT  
HOSPITALITY SUITE: \$149.00 / NIGHT  
APPLICABLE FOR FEBRUARY 9-16, 2010. ROOMS MUST BE RESERVED BY  
JANUARY 29, 2010 TO GUARANTEE THE CONVENTION RATE.

REGISTRATION\*  
\$45 UNTIL DECEMBER 31, 2009  
\$55 JANUARY 1, 2010—JANUARY 31, 2010  
\$70 THEREAFTER AND AT-THE-DOOR  
\*THE FINE PRINT: RATES ARE SUBJECT TO CHANGE WITHOUT NOTICE

[WWW.CAPRICON.ORG](http://WWW.CAPRICON.ORG)



# SUNDAY PROGRAMMING 12:00 – 2:00

**12:00**

## **Seeds of Girl Genius**

Romp through the history of science with Bill Higgins and examine the fabulous automata of the 18th Century, the science that gave rise to Frankenstein, and the hidden origins of Agatha's clan.

*B. Higgins*

**Lilac BD**

## **Alternative Technology**

What assumptions are made about steampunk technology? What is possible from a materials engineering standpoint and what breaks the rules of physics?

*E. Hunt, P.E. Kaldon, H. Spencer,*

*M.Z. Williamson*

**Junior Ballroom B**

## **Defining Steampunk**

A multi-textual, neo-Victorian movement seeking to re-establish an emotional connection between human and machine or just a rip-roaring story with steam engines. Some try to intellectualise it while others are looking for a great story. Share what S.P. is to you.

*J. Blaylock, D. Mead, J. Rovner*

**Lilac A**

## **Fanways**

Midwest fans are different from California fans are different from Boston fans — how? Join our fan panelists as they discuss fandoms they have known.

*V. Hoski, D. Smith, L. Zeldes*

**Lilac B**

## **Wigged Out**

Creating, modifying, and caring for costume wigs.

*K. Bergquist Dezoma, S. Edmonds,*

*R. O'Connor-Rose*

**Lilac C**

## **Reading**

*J. Hines*

**Walnut**

## **Autographings**

*K. Foglio, P. Foglio*

**Hallway**

**1:00**

## **What Our Things Say About Us**

If an alien invaded your room, what could it tell from your stuff? What do our things reveal about their owners? Can anyone tell?

*R. Green, R. Neumeier, J. Nye,*

*J. Smith-Ready*

**Lilac BD**

## **Age of Exploration**

In Victorian times there was still much of the earth left to explore. Not so much now, so we turn towards the stars. But robots and unmanned probes can do as much as, if not more, than humans can. So why do we still say we should go to Mars? What difference would humans make in extra-planetary exploration?

*P. Eisenstein, J. Helpers, T. Trumpinski*

**Junior Ballroom B**

## **Props to You**

Where do we get our wonderful toys? We build them of course! Come get ideas for the weapons, devices, and other bibs and bobbles to give your outfit that finishing touch.

*J. Ballard-Smoot, S. Edmunds, T. Foust*

**Lilac A**

## **Your Favourite Unknown (or Little Known) SF/Fantasy Author**

Who do you think is just terrific but no one else knows about him/her? Join our panelists as they reveal hidden gems for you.

*L. Thomas, M. Thomas, S. Silver*

**Junior Ballroom A**

## **Survivors:**

### **Do You Have What It Takes?**

Panelists discuss basic safety procedures and survival techniques for various situations including fire, loss of power, etc.

*B. Fawcett, C. Gerrib, R. Martinek,*

*P. Sayre McCoy, M.Z. Williamson*

**Lilac C:**

## **Reading**

*R. Chwedyc*

**Walnut**

**2:00**

## **Closing Ceremonies**

Say goodbye to our guests, find out who won what during the course of the con, and learn a bit about what we've got planned for 2010.

**Lilac BD**

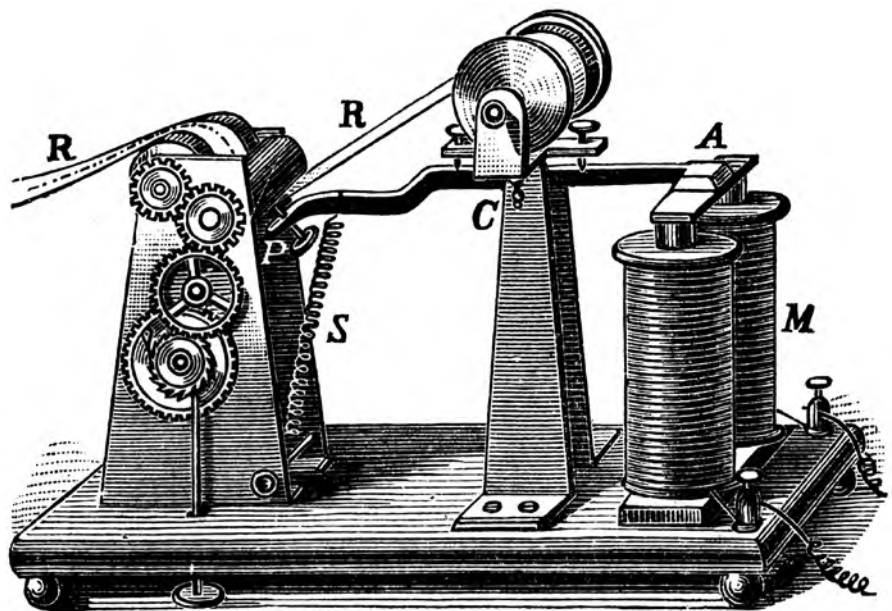

# FILMS

## FRIDAY

### 4:00 pm – *The Time Machine (1960)*

Steampunk from back when it was just called Science Fiction. A tinkerer from Victorian England travels forward in time to find that humanity has changed, and not for the better. Can he get back before dinner? Or before he is dinner?

### 5:30 pm – *Sky Captain and the World of Tomorrow*

In a super-cool 1939, reporter Polly Perkins (Gwyneth Paltrow) discovers that many of the world's scientists are missing. She teams up with her ex-boyfriend Sky Captain (Jude Law) to find out what's wrong. Special appearance by a rather vigorous looking Lawrence Olivier (who died in 1989).

### 7:30 pm – *Up*

78-year-old Carl Fredericksen (Ed Asner) finally decides to take the adventure of a lifetime he's been dreaming of. His mode of transportation is unconventional, his companion is a bit slow, and – squirrel! – the story is heartwarming, fun, and just really good.

### 9:00 pm – *Hellboy II: The Golden Army*

Hellboy (Ron Perlman) must defend the earth from an evil elf who wants to destroy humanity with the eponymous golden army. More fun and visually stunning.

### 11:00 pm – *Watchmen (Director's Cut)*

In an alternate 80s, there is no Wham! and a group of costumed superheroes must reunite to investigate the murder of one of their colleagues. They discover more than they bargained for. (this is rated R, folks, for violence, adult situations, and blue nudity)

## SATURDAY

### 10:00 am – *Atlantis: The Lost Empire*

Young Milo Thatch (Michael J. Fox) goes on an adventure to discover the lost city of Atlantis using his grandfather's maps to guide him. Geek cred: Joss Whedon wrote the treatment, Leonard Nimoy provides a voice, and Don Novello gets my favorite line in the whole show.

### 11:30 am – *20,000 Leagues Under the Sea*

The original Disney film with Nemo in it! Based on the Jules Verne novel, this film tells the tale of Professor Pierre Arronax and his companions who go in search of the malicious narwhal which has been destroying ships. Ahoy!

### 2:00 pm – *Dude, Where's My Car*

Yes! This is a science fiction film. Two stoners (Ashton Kutcher and Sean William Scott) wake up with no recollection of what happened last night. But based on the amount of trouble they're in, it must have been quite a night.

### 3:20 pm – *Chris Garcia discussing Dude, Where's My Car.*

In which our fan GoH explains why this is, in fact, a Sci Fi film (it does have the words "continuum transfunctioner" in it) and why it is awesome. See the film and stay after to hear his point and agree or disagree.

### 4:00 pm – *Monsters vs. Aliens*

When Susan Murphy (Reese Witherspoon) is hit by a meteorite, she is turned into a giant and classified as a monster. The government brings her to a secret compound where she meets other monsters. Together, they work to defeat the titular Aliens. Voice talents abound in this one: my favorites are Stephen Colbert and Hugh Laurie.

### 8:00 pm – *Art Auction*

### 11:30 pm – *X-Men Origins – Wolverine*

As the title suggests, this tells the origins of Wolverine (Hugh Jackman) as he fights throughout American history with his brother, Victor Creed (Liev Schreiber), and eventually gets the his cool adamantium skeleton and joins the X-Men.

### 1:30 am – *Sleepy Hollow*

Tim Burton directs Johnny Depp and Christina Ricci in this classic tale of Ichabod Crane and the evil Headless Horseman.

## SUNDAY

### 10:00 am – *The Rocketeer*

In 1938 Los Angeles, pilot Cliff Secord (Bill Campbell) finds a jet pack that allows him to fly. The bad news is, the evil Neville Sinclair (Timothy Dalton) wants that jet pack to give to the Nazis. Sinclair kidnaps Secord's girlfriend, Jenny (Jennifer Connelly) and Cliff, as The Rocketeer, must rescue her.

### 12:00 noon – *Up*

See Friday 7:30 PM

### 1:30 pm – *X-Men Origins – Wolverine*

See Saturday 11:30 PM

# ISFIC WRITERS CONTEST WINNER

Since 1985, Illinois Science Fiction in Chicago has been holding a writing contest for beginning writers of science fiction and fantasy. Our annual convention, WindyCon, emphasizes the literature of science fiction and we want to encourage new writers. The winning story is published in the WindyCon program book. What better encouragement than seeing your story in print!

There is no entrance fee, but the entrant must not have been paid for any previous work of fiction. The top three will be contacted by WindyCon beforehand, so they can attend and receive their prizes. Our judges include both authors and editors. Full rules are at WindyCon.org and ISFiC.org.

This year's winner is John M. Cowan with *Oracle*. Honorable Mentions go to Treva Rodemaker for *Local Color* and Diana Robicheaux for *Curse of the Underwearwolf*.

Special thanks go to our judges, Roland Green, Betty Ann Hull, and Bill Fawcett, for reading all of the submissions in a very short span of time. All agreed that most of the stories were well-written and worth reading. Let's keep it up!

To all aspiring authors: We had 5 short stories in 2008 and added another 9 entries this year. We want to see your entry next year! You can do it! If your confidence needs a boost, don't forget that WindyCon also holds a Writer's Workshop. Do one, do both, just do!

*Marcy Lyn-Waitsman*  
*Writers' Contest Administrator*

## Oracle

by John M. Cowan

### IT'S CRYSTAL CLEAR: PROFITS FUND LAVISH LIFESTYLE

Workers here on Station Celeste pay 32 credits for data storage crystals that cost Administration just 6 credits, according to this invoice from HPackCorp. Where does the profit go? Station overhead accounts for some, but this internal report on Purchasing Supervisor Ross Barstowe's relationship with MarsWare and other vendors on the Outer String suggests that much of the excess money funds Barstowe's lavish 2-Level apartment and lifestyle, which includes parties, rare Sirillese artwork, and two mistresses (*fotos [here](#)*)...

—*Oracle* (Net Posting Address unknown), 8.23.2132

He recognized the voice in his ear right away: "Duncan? Is Chris Tanos. Hey, Meeran diplomat was admitted to station hospital last night. News for your—"

Stop! Duncan Leamas wanted to shout. Not over an open channel! Instead he broke in with a sharp "Call me when you're sober."

Duncan cut the connection and glanced nervously around the cramped cubicle he shared with Janell. Chris would be mad, but Station Authority would throw Duncan into confinement if they connected him to Oracle. Hadn't Tanos ever heard of Echo monitoring?

The earlink chirped. "Incoming call from unidentified source—"

"Accept."

"Duncan." Chris sounded apologetic. "I forget."

"That's all right. What's the flash?"

"Name is Dajo, something more but Dajo is all I heard. Meeran embassy attaché. They carry him into station hospital last night. Trouble breathing, spasms, delirium."

"Where'd you get this?"

"Is name Ben Koprowski. Med attendant."

"Koprowski. I think I know him." Contrary to Janell's opinion, Duncan didn't know every single one of the 832 inhabitants of Station Celeste. Maybe half. "He likes action serials, right?"

"Is him. His shift is 1600 to 2400. Lives on 9 level."

"Okay. Thanks for the flash."

"What's with Chris?" Janell asked.

He turned. Janell lay on their cot, scratching her short red hair while playing MarsWar on her gamepad. Ready for sleep, as soon as Duncan left for his job at Docs and Trans. Looking at her legs stretched out on the sweaty sheets, he considered showing up late. But he'd been late three times this quarter.

"One of the Meerans went to the hospital last night. I'd better check it out."

She smiled, sleepy. "The station needs to know."

He kissed her. "Right."

APRIL 16 - 18, 2010

# C2E2

Chicago Comic & Entertainment Expo  
at McCormick Place

"The con Chicago needs.  
The con you deserve!"

WWW.C2E2.COM

twitter: @C2E2

blog: www.mediumatlarge.com

Produced by:

Reed Exhibitions



## Oracle - by John M. Cowan

### AIR CHIEF'S QUALIFICATIONS SMELL

The recently-appointed Chief of Atmospheric Integrity and Quality has no background in atmosphere systems and only eight months of experience in any form of environmental management. Before his short stint in the accounting section of Environmental Systems on Luna's Station Tycho, Eli Dawes worked as an Asset Management Specialist for Oversight Insurance Corp. and a Claims Arbitrator for the UNEarth's North American Office of Property Damage (See Dawes' résumé [here](#)). Co-Administrator Skillings defended Dawes' hiring on his office's NetSite, saying "Eli Dawes has a demonstrated ability to make decisions, learn quickly, and preserve vital resources." Dawes will receive a salary of 132,000 creds and is eligible for a 20 percent raise after twelve months...

—*Oracle* (Net Posting Address unknown), 8.31.2132

Duncan had lived on Station Celeste for three years. He'd been posting Oracle—anonously and untraceably—for two and a half. One night, in the beginning, Janell stared at him from their cot while he worked on an entry. "Why are you doing this?"

His eyes burned from staring at the screen too long. Two off-duty security officers had gotten drunk and trashed a bar, and then arrested three workers to blame the damage on them. Administration would deny everything he wrote, of course, but with any luck they'd get quietly fired within the next month.

He shrugged. "Because—" It's what I do. Who I am. The only job I know. "People on the station need to know this stuff."

"They don't want to know it."

"That's why they need it."

Now he stood in the corridor outside Ben Koprowski's compartment, after skipping out early from his shift in Documents and Translation. Docs and Trans suited his background. He'd been a journalist on Earth and then on the Outer String. Before they'd fired him.

Stale human odors hung in the air. Air scrubber maintenance on 9 level wasn't a priority. Doors began sliding open as Second Shift began heading out to report to work. A middle-aged woman nodded to Duncan without speaking. She'd tipped him off last month to the pilots who paid kickbacks for shipping runs to the String. He smiled and kept his eyes on Koprowski's door.

It opened and Ben Koprowski ducked his head to lurch into the corridor. Tall and skinny, he had gray hair and a red face. Duncan waited for him to lock the door, then fell into step with him as he headed for the lift. "Hi, Ben."

Koprowski glanced over his shoulder and decided to ignore him. "Do I know you?"

"Friend of a friend." He reached into a pocket and held up a vid disk. "They tell me you're the biggest fan on the station."

Koprowski shook his head in disgust. "Not interested in porn—"

"The latest season of Mutant and Martian." He'd gotten an advance bootleg from Menyatta, who ran all sorts of contraband through the docking level.

His eyes bugged. "What—really?"

"Chaz gets captured by Ringlander terrorists, and there's a virus in Sirtis City—"

"Don't tell me!" He dug into his pants. "How much do you want for it?"

"Not station creds. Just information. Dajo, the Meeran they took into Station Hospital yesterday?"

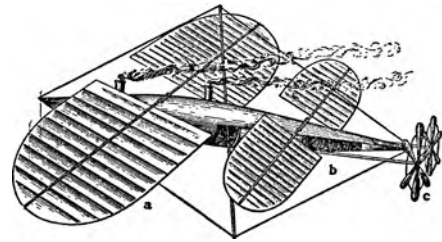

His eyes darted up and down the passageway. "I'm not supposed to tell anyone about him."

"I'm not supposed to have this vid."

He hesitated. "Let me see."

Duncan slipped the vid into a handviewer and held it up to Koprowski's face, fast-forwarding the recap scenes from the previous season. Music announced the new episode and he stopped the action. "Well?"

Koprowski trembled with excitement. "Okay. He came in at 0322. Delirious, and trembling, and feverish. They sent him right into isolation. The consulate is in the dark, don't notify them—that's the order."

"What cubicle?"

"Isolation 12. You didn't get this from me."

"And you—" he tossed the vid— "Didn't get this from me. Enjoy."

"Thanks!" Koprowski hurried back to his compartment to save the vid for later. Duncan got out of sight before he emerged.

Confirmed—but not nearly enough to post on Oracle yet. He could hear Jackson's questions in his head as if she was shouting all the way from the Outer String. "Okay, okay," he muttered, opening his comm and punching an ID. "Bundi? It's me. You know anybody who's been admitted to the hospital?"

# ANIME

## FRIDAY

### 6:00pm - *Le Chevalier D'Eon 1-4 (13+)*

A coffin floats in the shimmering Seine, inside, the body of a beautiful woman: Lia de Beaumont. Now her brother, D'Eon, seeks the reason for her mysterious murder.

### 7:40pm - *Howl's Moving Castle (Miyazaki) (7+)*

Sophie, a quiet girl working in a hat shop, finds her life thrown into turmoil when she is literally swept off her feet by a handsome but mysterious wizard named Howl.

### 9:40pm - *Steamboy (13+)*

Victorian London is attacked by an army of futuristic, mechanized war machines and only Ray Steam who knows the astonishing secret behind the invasion force's incredible powers stands between the city's survival and ultimate destruction.

### 11:45pm - *Ghost Hunt 1-4 (14+)*

The appeal of the unknown is undeniable and freshman Mai Taniyama is hooked. This fact, coupled with her burgeoning psychic powers, leads Mai to join the ranks of the Shibuya Psychic Research team.

### 1:25am - *D.Gray Man 1-4 (14+)*

Darkness is moving in, and young exorcist Allen Walker is humanity's greatest hope against the forces lead by the dread Millennium Earl.

### 3:05am - *Shutdown*

## SATURDAY

### 10:00am - *Fruits Basket 1-4 (13+)*

The Sohma family is cursed. When a member of the family is embraced by a person of the opposite gender, they transform into an animal of the Chinese Zodiac!

### 11:40am - *Shonen Onmyouji 1-5 (13+)*

A demon drops from the sky and proclaims that Masahiro must continue his grandfather's work and learn to be an Onmyouji regardless of the dangers that await him.

### 1:45pm - *Kaze no Stigma 1-4 (14+)*

Defeated by his younger cousin Ayano in a battle to become the clan's successor, Kazuma is exiled with only the smoldering burn of failure to keep him company. Now he's back and armed with powerful wind magic.

### 3:25pm - *Spiral 1-4 (13+)*

Ayumu Narumi's brother disappeared two years ago while investigating the mysterious Blade Children. Now the Blade Children are appearing from the shadows and their target appears to be Ayumu.

### 5:05pm - *Last Exile 1-4 (13+)*

Claus and Lavie take on the mission to deliver a mysterious girl Alvis to the battleship Silvana. They soon become entangled in an aerial adventure between two countries gripped in an eternal war of magnificent air battleships.

### 6:45pm - *Origin: Spirits of the Past (13+)*

A young boy named Agito enters a forbidden sanctuary where a glowing machine resides. This machine preserves a young girl named Toola, who has a mission entrusted to her from the past.

### 8:15pm - *Steamboy (13+)*

See Friday, 9:40pm

### 10:20am - *Moon Phase (Tsukuyomi) 1-5 (15+)*

When Kouhei tries, and fails, to capture a hauntingly beautiful young girl on camera, curiosity drives him into the arms of a seductive vampire and into a world he cannot comprehend.

### 12:25am - *Trinity Blood 1-4 (15+)*

Abel Nightroad, a touring priest for the Vatican, is tasked with the protection of the fragile equilibrium between humans and vampires.

### 2:05am - *Baccano 1-4 FUN (17+)*

This caper ain't about a simple gangland brawl. It's about hoods who can't seem to die properly after catching a bullet or five between the eyes. Sadistic hit-men and the dames they love, and soul sucking alchemists bootlegging an elixir of eternal life.

### 3:45am - *Shutdown*

## SUNDAY

### 10:00am - *Howl's Moving Castle (Miyazaki) (7+)*

See Friday, 7:40pm

### 12:00pm - *Romeo & Juliet 1-4 (13+)*

Juliet prepares to raise her sword and lead a rebellion against the villainous tyrant whose hands are stained by the blood of her ancestors.

### 1:40pm - *Requests*

These shows are courtesy of:

**Funimation Productions**

[www.funimation.com](http://www.funimation.com)

**Studio Ghibli/Walt Disney Productions**

[disney.go.com/disneyvideos/animatedfilms/studioghibli/](http://disney.go.com/disneyvideos/animatedfilms/studioghibli/)

## Oracle - by John M. Cowan

### BIRTHDAY BASH, BUT NO BIRTHDAY SUITS

Bodydancers from the Inner Belt did not perform at Chief Administrator Gravette's recent birthday party, despite rumors that the hypersexed women were paid 4,000 creds apiece for sexual entertainment at the celebration. Recordings of the party indicate that one of the dancers briefly accompanied Information Tech Manager Leon Harding but left before Gravette arrived. Gravette's office blames the rumors on political rival Christine Lomar; two of Lomar's aides were reassigned to Systems Monitoring after being questioned by Security...

—*Oracle* (Net Posting Address unknown), 9.14.2132

Package under one arm, Duncan slid his ID card through the reader. "Visiting patient Joseph Cantu." After processing his card and voice, the grid displayed a cube number and Hospital chart. Then the door slid open.

Two security guards looked him over. Station Hospital was a tempting source of drugs, although most of the trade went through the guards themselves. One guard wore earphones, tapping his hand on the butt of his pistol in time with the music from his player. The other's eyes were hidden behind a visor watching the security feeds, or maybe the latest exotic Asian porn. They ignored him as he passed by.

Cantu was under sedation. Most patients were. Hospital execs said it facilitated treatment, but unconscious patients couldn't argue or complain. He lay in a tub of clear biofluid while thin white tubes pumped in the medicines to help him recover from heart surgery. The biofluid needed skimming—spots of waste material floated on the surface like stains.

Duncan opened his package, a picture cube that displayed 3-D images of mountains on Earth. He turned a view of the Himalayas toward Cantu's face and talked for a few minutes in case anyone was monitoring the room. "Well, it's been nice," he said. "See you soon. I'll tell your mother you're looking good." She worried—her son had been in here almost a week.

He turned the wrong way in the corridor and wandered for five minutes as if lost. He saw old people, children, broken limbs, burns, surgical scars, and restraints. No doctors. Equipment patched with gray duratape. Foul odors the air scrubbers couldn't erase. Time for an exposé on Hospital, he thought when he reached Dajo's isolation unit.

Unlike the other cubes, which were open to every passing eye, the isolation unit's walls were opaque; only a circular window in the door, with a dent in the plastic screen,

offered any view of the room inside. No guards on the door, but it didn't slide when Duncan tried to open it. He took a quick glance up and down the corridor and peered inside.

The Meeran lay on a bed. Meeran arms were long and slender; their legs were short and powerful. They had pouches in their abdomens to carry and nurse their young. Dajo's face was furry and flat, with three nasal slits between his round black eyes. He was hooked up to—Duncan counted—seven different instruments. Duncan tried to read the numbers on the equipment. Pulse looked strong, but temperature was in a red zone. Respiration was low. Brain activity just below normal. He activated his handcomp and entered all the data he could see—med readings, equipment models, the number of tubes sticking into Dajo's body. He pressed the door control again.

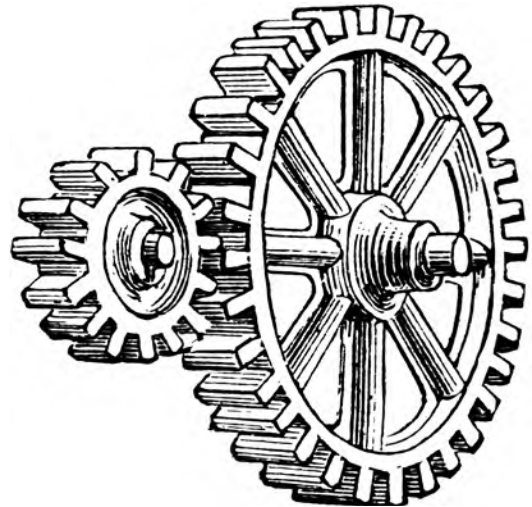

"You! Step away from that door!"

Busted. Duncan jumped back, lifting his hands. "I was just—which way is out? I'm visiting my friend and I got turned around, I think. Hey, is that a Meeran in there?"

"That's nobody that's any of your business." The guard, his visor dangling around his neck, glared at Duncan but kept his sidearm holstered. "You need to get going."

"Sorry. I was just—"

"Just go!" The guard, a kid maybe twenty years old, looked more nervous than annoyed. "Before I report you." Which he didn't want to do, because he'd have to admit that he let someone get close to the isolation unit.

"I'm out of here." Duncan backed away. The guard watched him, sweating. Duncan turned around and scampered toward the Exit sign.

He'd already checked the Station database, which sketched the history of human-Meeran relations but said next to nothing about their physiology. He needed an expert. And he knew just the person.

# MARCON 45

**Theme:**

***A Year of Horror***  
*with Zombies, Vampires*  
*and Monsters under your bed,*  
*Oh My!*

**May 28 - 30, 2010**

**Hyatt Regency, Columbus Ohio**

**Author:**

**Wen Spencer**

**Costuming:**

**Tom Savini**

**Artist:**

**Billy Tackett**

**Gaming:**

**Twilight Creations**

**Filk:**

**Seanan McGuire**

**Special Theme:**

**Central Ohio**

**Paranormal Society**

**[www.marcon.org](http://www.marcon.org)**

**\$35 until Dec 31, \$40 until May 9, \$50 at the door**

## Oracle - by John M. Cowan

Fyr'filla was a Ferellian who tended bar at the Station House on 4 Level. He'd been exiled from the Ferellian system for reasons he wouldn't discuss. Everyone expected that his three arms would make him quicker and better at serving drinks than a human bartender, but he spilled more booze and dropped more bottles than any bartender Duncan had ever seen. His studies in religion and philosophy hadn't prepared him for a career of pouring drinks.

The Station House was quiet, close to empty, but Fyr'filla was behind the bar. He grabbed for a beer mug as Duncan walked in, dropped it, and let loose a long, musical curse and slammed three fists on the bar in frustration. "I'll never master this skill."

"Hey, Firefly. What do you know about Meeran physiology?"

With all three hands, he poured Duncan a shot of whiskey. "I'm a philosopher. I know that sounds very similar to 'physiologist' in your language, but in the For'a tongue—"

"What's that saying from Mak'tiradu you're always quoting me? 'The goblet shapes the wine.'" He drank his whiskey. "Biology influences culture and beliefs and philosophy, that's what you used to study, and nobody knows all the alien cultures on Station better than you do. Give me another whiskey."

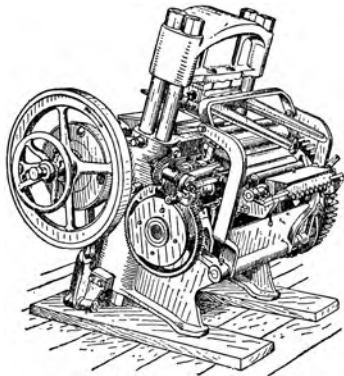

Again he poured with care. "I've never seen a Meeran in here. They have a short lifetime by human standards, and they've evolved many defenses against injury and disease. They do not fall sick often."

Duncan showed the Ferellian his handcomp. "Then something strong hit this one. Can you tell me anything from these readings?"

Fyr'filla snatched the instrument from his hand. Any problem that distracted him from the world of dirty beer mugs was a reward in itself. "I must...give me time... May I download this?"

"Use the encryption mode. And give me another whiskey."

### HOLY MESS: DIVERSITY TRAINING TO ENCOURAGE HARASSMENT

Three Environmental Control employees have been reassigned after allegations of religious non-harassment. Samuel Baynes belongs to the Temple of Martyrs, a sect which considers itself under constant attack to renounce its religious beliefs. Martyrs often complain that tolerance of their views is in itself a form of harassment, "stealing" their opportunity to defend their faith (See [tract here](#)). Environmental Control personnel will receive Diversity training on Temple of Martyrs beliefs to avoid similar incidents...

—Oracle (Net Posting Address unknown), 10.05.2132

He kissed Janell, rolled over, and pulled on his pants. "Tea? The mint is just in."

She wiped sweat from her forehead. "Most of my boyfriends use that to get me into bed, not afterward."

"I always do things backward." He found a pair of dirty mugs and hit the hot water button, watching the ration meter count down. Janell was probably joking about the other men.

She reached for a shirt and stretched. Duncan watched her. Janell worked in the Commissary office. They'd met while he checked out a story on Administration officials helping themselves to food items reserved for visiting dignitaries. He'd been intrigued by her quick laugh, her lack of tolerance for bullshit, and her short, slim body filled with energy. She'd moved into his tiny cubicle a week later.

"What about that Meeran in Hospital? Any news?"

"Firefly's working on some stuff." He crossed his legs in front of their terminal and checked his stories for the next posting. Minor items—pilferage, unauthorized downloads, an Administration attempt to access personal files. The Dajo story would be a good attention grabber. If it didn't take too long to find something solid. He had no deadline: Oracle was posted whenever he had enough stories. But long gaps between releases risked losing people's interest.

"Why do you do that?" Janell asked.

"You asked me that already." Twenty-seven times over the last fourteen months.

"And you don't ever answer, asshole."

"It's important. Isn't that an answer?"

"No. Why's it so important to you?" She jabbed her finger at him. "Duncan Leamas? It's got to be more than just staying in practice until someone offers you a real job again."

"Since that's not ever going to happen, yeah."

She crossed her arms. "So why? Give me a real answer."



INCREDIBLE STUFF, UNBELIEVABLE PRICES!

AMERICAN SCIENCE & SURPLUS

WE HAVE YOUR STUFF!

Tools \* Components \* Materials  
Parts \* Workings \* Apparatus  
Supplies \* Devices \* Machinery  
Mechanisms \* Equipment \* Gear  
Paraphernalia \* Hard-to-find  
Plus lots of weird stuff!

Shop online at [www.sciplus.com](http://www.sciplus.com)

Geneva/West Chicago store:  
33W361 Rt. 38/Roosevelt Rd.  
(1/4 Mile East of Kirk Rd.)  
Geneva, IL 60185  
630-232-2882

Chicago store:  
5316 N. Milwaukee Ave.  
(at Central Ave.)  
Chicago, IL 60630  
773-763-0313

# PARTIES

Good day ladies and gentlemen. Had a long day of complicated inventions? Some that may not have turned out quite right? Need some time to just relax and share ideas with your fellow geniuses? Then takes some time and visit the parties.

Per normal, your favorite parties will be receiving awards for their achievements in the following areas:

- ☞ Best Overall Party
- ☞ Best Drink
- ☞ Best Steampunk / Victorian Decor
- ☞ Best Overall Decor
- ☞ Best Victorian Food

Ballot collection boxes for your votes will be located on each party floor. Make sure to include your badge number on your ballot. There is only one vote per person, so make sure to vote.

This year's parties include, but are not limited to,

- ☞ Barfleet
- ☞ Minicon
- ☞ Chicago SF
- ☞ Bourbon Tasting
- ☞ GT
- ☞ Chicago in 2012
- ☞ Capricon 30
- ☞ Elven Toast
- ☞ NakamaCon / TeslaCon
- ☞ Evening Tea at Mamma Gkika's

Do not forget to keep these rules in mind as you participate in each evening's festivities.

- 1 The legal drinking age in Illinois is 21 and the parties will be checking IDs at the door, so please be sure to have your ID on you at all times.
- 2 Be respectful of the hotel and the others around you.
- 3 The Westin is a NON-smoking hotel. If you wish to smoke you **MUST** go outside.
- 4 Please dispose of all trash in trashcans.
- 5 Keep the parties in the party rooms not the hallways.
- 6 REMEMBER! If it illegal in the non-convention world, it is illegal in the convention world too.

Were You Dressed Funny This Weekend?

**COSTUME CON 28**  
May 7-10, 2010 Milwaukee, WI

**CC28**.ORG

## Oracle - by John M. Cowan

The problem was that he didn't have one. It had something to do with showing Administration they weren't omnipotent, that they had no right to screw the people who worked on the station. Something to do with anger at being fired, needing to prove himself to Jackson and everyone else. And everything to do with the fact that he'd never really done anything else with his life. Not being sure he could. That scared him.

"To meet girls," he said.

"Asshole." She threw his underwear at him.

Before he could respond the door slid open. He jabbed a button on his terminal and twisted around—

"Duncan Leamas?" Two security guards. At least they weren't wearing full armor. "You're coming with us."

"Hey, I'm not dressed here!" Janell snapped, pulling sheets up around her body.

"What is this?" Duncan untangled his legs and stood unsteadily to his feet. "You can't just—"

One guard held up a hand viewer. "Warrant for questioning. Get a shirt and come on."

He examined the doc. Legitimate. He shrugged. "Whatever."

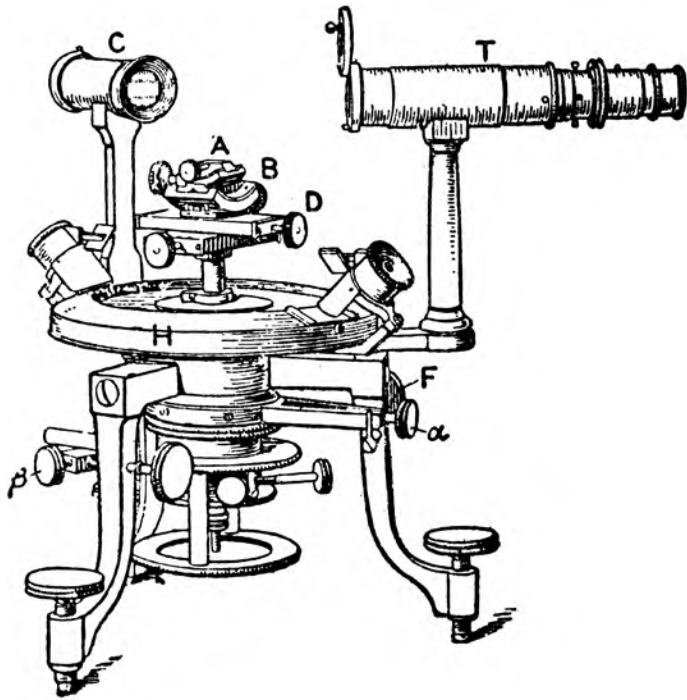

Station Investigator Eileen Arvin sat behind a black metal desk, glancing back and forth between Duncan's face and a computer screen. Her big eyes and slender build made Duncan think of a cougar—sleek and dangerous. "You visited Joseph Cantu in Station Hospital."

"His mother asked me to bring him some pictures."

"Then you went looking for Trejean Dajo."

"I didn't go looking. I got lost."

"You were spying on his cubicle."

They were taking this seriously.

"I never saw a Meeran before. I was curious."

"Trejean Dajo is a senior diplomat. You're a level-two document specialist. What did you want to see?"

"An alien. What's the big deal?" His voice rose.

"Stay calm. I see here—" she gestured toward her screen—"You used to be a reporter on the Outer String. What brought you to Station Celeste?"

"I had to quit. Before they fired me." The anger came rushing back despite himself. "I fabricated a quote."

Asteroid miners had died in an accident caused by defective equipment. The corporation knew the driller might explode. He had the documentation. But no one would talk to him on the record, so he'd quoted an unnamed supervisor to confirm the details. The supervisor didn't exist, and Jackson started pushing him about it. In the end he had to quit. Not so much to avoid getting fired, really, but to save Jackson from getting her ass kicked off the String for defending him.

Arvin leaned back in her chair and sighed in frustration. "I've got nothing to hold you on, Leamas, so let me just give you some advice. About talking to anyone about Dajo: Don't."

"I didn't see any—"

"This station breathes gossip and lies like bad air. Net postings, that Oracle thing—" She paused. "You know what I'm talking about, don't you?"

Duncan's chest tightened, but nothing in Arvin's expression suggested anything more than a simple question. "Yeah."

"Oracle posts half-truths and lies all the time." She shook her head. "It's garbage. Right?"

She was waiting for an answer. After a breath, Duncan nodded. "All right."

"We're going to find the people behind Oracle, and when that happens we might give them a suit before we throw them off Station. Or we might not. In the meantime—" She leaned forward—"if they happen to report on a viewing of Dajo in Hospital, I'll know who they've been talking to. And you'll be back here and you won't be going back to your girlfriend anytime soon. So don't talk to anybody. Got it?"

Duncan forced a slow nod. Don't say anything. Just leave.

"Got it?" Waiting for an answer.

"I understand. Is that it?"

Arvin frowned. "Get out."

# DuckKon 19

STILL UNDER CONSTRUCTION



**June 18th - 20th, 2010**

**Holiday Inn Select, Naperville, Illinois**

**Literary Guests of Honor: Sharon Lee & Steve Miller**

**Filk Guest of Honor: Talis Kimberley**

**Fan Guest of Honor: Scott Raun**

**PLEASE WATCH THE WEBSITE FOR FURTHER DETAILS:**

**WWW.DUCKON.ORG**



## Oracle - by John M. Cowan

"Are you all right?" Janell sounded out of breath through the comm. "I almost called Uncle Zach."

"Calling Uncle Zach" was a routine he'd worked out with Janell in case Administration brought him in for questioning about Oracle. She'd post an issue while he was in custody, filled with saved items he updated every few days. Administration would see right through it, of course, but it would slow them down and maybe force them to let him go for a while.

"I'm fine," said Duncan, even though he was trembling with anger. "No need to bother Zach. I'm going to get some breakfast and get to my shift."

"Oh. Okay." She sounded pissed off. At Security, or at him? Duncan couldn't tell and didn't care. "I need to get some sleep." She cut off.

Half-truths and lies? Gossip? Garbage? Was Arvin as corrupt as everyone in Administration, or just too stupid to see the truth? Everything Duncan posted was confirmed, every name, every number, every comma. Arvin had to know that. What did she think—

Unless she'd been feeding Duncan a line of bull. Hoping to trick him into a mistake that would connect him to Oracle. Duncan leaned against a bulkhead for a deep breath of stale station air. Control, he told himself. Don't let them run your emotions.

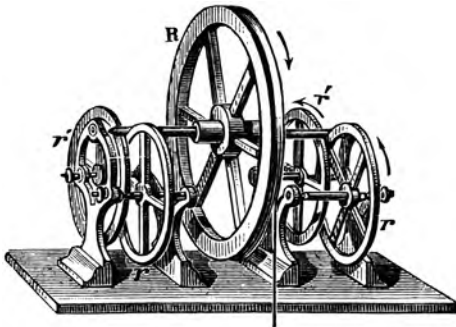

Station House was more crowded, and Fyr'filla had help behind the bar, a human female with no hair on her head and scarlet tattoos on her forearms. Duncan ordered a whiskey and some eggs from her while he waited for the Ferellian to have a free moment.

"Anything about our friend?" he asked as Fyr'filla cautiously pulled glasses from the washer.

"He's dying," Fyr'filla said.

Duncan's stomach lurched. "What?"

"Or possibly having a baby. Male Meerans carry fetuses for several months before transferring them back to a female, did you know that? I checked every database I could find. Unless you get more data I can't tell you if he's on his deathbed or getting ready to pass a stone."

Duncan grimaced. "Great."

"But I'll tell you what—it must be something serious." Fyr'filla leaned in and lowered his voice. "Word is a military delegation from the Meeran Embassy on Earth is heading here."

"Where'd you hear that?"

He waved one arm toward Sheila, the other bartender. "A bunch of security officers were in a few hours ago," Sheila said, helping Fyr'filla with the glasses. "Complaining about extra defense drills because of some Meeran assault group from Earth. They're scared."

"When are they coming?"

"Next few days. Maybe a week. These guards were looking for courage in a bottle. You want another whiskey?"

"No." A Meeran assault force? Station Celeste couldn't defend itself against a serious military threat. Maybe the Meerans thought this was an assassination attempt. Maybe they were right...

"Damn it." There was no way around it. He had to talk to the Meeran himself.

### BET ON IT: SUPERVISOR'S LOSSES SPARKED GAMBLING PROBE

Two Docs and Translation Section workers were released from Security Confinement and reassigned to Recycling Operations pending a hearing on allegations of inappropriate Network use. The two had been charged with running a gambling operation based around the popular Net game Rings of Doom. An investigation determined that anonymous complaints about the operation came from their supervisor, Darla Hemming, whose losses on the Rings game totaled over 17,000 creds. Hemming is being transferred to an Outer String station. (*See the official report [here](#), and readouts of the account for DamnedGirl, Hemming's Rings [alias](#), [here](#)...)*

—Oracle (Net Posting Address unknown), 11.10.2132

"Is bad idea, Duncan," Chris Tanos said.

"Don't I know it." Duncan wore a white cap and a gray hospital attendant's uniform. It had a dark stain in the chest. He followed Chris through the hospital's employee entrance.

Janell thought it was stupid, too. He wasn't sure she'd be there when he got back—if he got back. The prospect of a long stay in detention was harder to contemplate if he thought she might never speak to him again.

Both were chances he had to take. Dajo's illness, and the Meeran assault group's mission, could spark a diplomatic incident between races—and get people on Celeste killed. Station workers had a right to know.

## Oracle - by John M. Cowan

You're an idiot, he thought. Then he spotted the door and pushed his worries out of his mind.

Chris, his fingers shaking, punched a code into the panel next to the door. "Okay," he whispered. "Good luck."

The door slid open. Chris walked away, muttering to himself.

Duncan slipped inside. The smell was a mixture of chemicals and unpleasant bodily odors. Dajo lay on the bed, his fur matted and sweaty. Eyes half closed, he moaned softly.

Duncan peered at the readouts on each piece of equipment. Respiration was a little better, and brain activity had improved some, but the fever was still high.

"Uhh," Dajo groaned. "Mraolo ishpa la donnu?"

He reached beneath the uniform for his handcomp and set it to translate as Dajo continued murmuring in his native language. The translation program caught individual words—"head," "water," "mother," and some obscenities involving genitalia. Dajo seemed delirious.

Duncan frowned at the equipment readouts he didn't recognize, a jumble of jagged lines, multicolored shapes, and stark impersonal numbers. He lifted the handcomp and shifted it to visual record, trying to focus in on the data—

—And Dajo grabbed his arm like a drowning man dragging himself into a rowboat. "Kila!" he whispered in a raspy voice. "Kila!"

"What?" Duncan's heart thudded and he almost dropped the handcomp onto Dajo's chest. "What do you—"

"Kila!" His black eyes bulged in—desperation? Excitement? Duncan knew better than to assume he could read alien body language. He pulled Dajo's fingers from his arm—the Meeran's grasp was weak as a human child's—and quietly asked "What do you want?"

"Kila nozzer wann wann..." Then he closed his eyes and threw up. Duncan jumped back, but couldn't avoid some of the spill of whatever had been in Dajo's stomach on his shoes. Foul.

Time to go. The med staff monitoring Dajo would probably notice his return to brief consciousness and Duncan needed to be gone before anyone asked him a question he couldn't answer. He slid the door, turned for one last look at Dajo, and caught another whiff of vomit. Disgusting, but something in it was faintly familiar. Almost like...

"Kila," Dajo whispered, and Duncan smiled. He knew.

"He's drunk?" Janell peered over Duncan's shoulder as he tapped his keyboard.

"Tequila. Meeran bodies don't metabolize it very quickly. He'll be intoxicated for a week. And hung over for a month." Duncan laughed. "He may be the first Meeran to get drunk and live to talk about it."

"And this is news?"

He looked at her. "Of course it is—a military assault force is on the way here. Meerans aren't supposed to have access to alcohol. Firefly checked the bars around Station House and found one that sent a bottle to his habitat, but station security delivered it. Maybe they really were trying to kill him, but probably someone just screwed up. And Administration is trying to cover it up and they might get us into a war here."

"All right! All right." She sank back on the bed. "I'm just glad nobody reports on me when I've got a hangover."

He glared at the screen. Where was he? His earlink chirped: "Incoming call from Christakos Tanos."

Damn it. "Accept. Chris, what's up? I'm in the middle of—"

"Duncan! I am fired."

He blinked. "Huh?"

"Hospital tell me they reevaluate my record. Terminate. I don't know. I report to Resource Center, get reassignment—Environmental Maintenance, grade 4. Bastard."

Grade 4 was the second-lowest pay rate on Station. "Chris, I'm—did they tell you why?"

"Bastard," Chris spat, and Duncan flinched in guilt. But then Chris said, "Bastard Doctor Fielding never want me there, look for any reason. But I know why. You know why."

Duncan stared at his words on the screen. Chris had a family. "You know, I'll ask around, maybe somebody has a job—"

"Forget that. Get the bastards, Duncan. Just get them." Chris cut the link.

"You got Chris Tanos fired?" Janell asked.

"Uh-huh." He didn't have the nerve to look at her.

"Sons of bitches."

His fault. Station was run by corrupt, petty bureaucrats only interested in their own power, but Duncan had gotten Chris fired. Damn it!

Nothing he could do. Not now. Except one thing ...

The story went at the top of the post. Big flashy head:

### **BOTTOMS UP: MEERAN DIPLOMATIC CRISIS SPARKED BY TEQUILA.**

One last check for spelling. Then—

Send. He sat back, folded his arms, and closed his eyes. One more Oracle posting on the Station Net.

Station needed to know.

# FOOD GUIDE

## 34 Places to Eat Without Crossing the Street!

This is just a short list of all the great places to eat in the area. For a complete list of over 100 dining establishments, please stop by our information desk, just off of the lobby, or you can find our online version at [foodguide.memnison.com](http://foodguide.memnison.com)

*Food Guide researched and written by:*  
Kathy Horning & Jim Rittenhouse

### INSIDE THE HOTEL

#### Harry Caray's

Steakhouse

630-953-3400

F & SA 5pm - 11pm, SU 4pm - 9pm

Reservations / Call Ahead Seating

Sandwiches \$10-17; Entrees \$15-45

[www.harrycarays.com](http://www.harrycarays.com)

#### Holy Mackerel!

Seafood

630-953-3444

F & SA 4pm - 11pm, SU 4pm - 9pm

Reservations / Call Ahead Seating

Sandwiches \$9-18 (L);

Entrees \$11-19 (L) \$14-65(D)

[holymackerelseafood.com](http://holymackerelseafood.com)

### NEXT TO THE HOTEL

#### Target

Decent sized grocery department.

630-495-9560

M-Sa 8a-10p, Su 8a-9p

#### Pizza Hut Express

Inside the Target

Pre-made personal pizzas  
and sandwiches.

630-495-9560

M-Sa 8a-10p, Su 8a-9p

#### Starbucks

Inside the Target

Coffee and Pastry

630-495-9560

M-Sa 8a-10p, Su 8a-9p

### INSIDE YORKTOWN MALL

Limited to Mall Hours

M - SA 10am - 9pm, SU 11am - 6pm

#### Arby's

Fast Food / Sandwiches

630-268-8100

Sandwiches \$2-5

[www.arbys.com](http://www.arbys.com)

#### Auntie Anne's

Fast Food / Soft Pretzels

630-627-4513

Pretzels \$3-4

[www.auntianne.com](http://www.auntianne.com)

#### Caribou Coffee

Coffee and Pastry, Breakfast

630-424-8754

[cariboucoffee.com](http://cariboucoffee.com)

#### Charley's Grilled Subs

Fast Food / Sub Sandwiches

Sandwiches: \$5-8

#### Cinnabon

Fast Food / Cinnamon Rolls,

Coffee & Pastry

Coffee and cinnamon rolls \$3-5

[www.cinnabon.com](http://www.cinnabon.com)

#### Dairy Queen

Fast Food / Frozen Treats

Soft Serve ice cream \$2-6

#### Hot Dog Lady

Fast Food / Sandwiches

Sandwiches: \$3-6

#### Kato's BBQ & Grill

Fast Food / Pan Asian

630-889-8028

Entrees \$4-6

#### McDonald's

Fast Food / Burgers

Sandwiches \$1-5

[www.mcdonalds.com](http://www.mcdonalds.com)

#### Panda Express

Fast Food / Chinese

630-620-9873

Entrees \$6-8

[www.pandaexpress.com/menu](http://www.pandaexpress.com/menu)

#### Sakkio Japan (a.k.a Sarku)

Fast Food / Japanese

630-620-9379

Entrees \$3-7

[www.sarkujapan.com](http://www.sarkujapan.com)

#### Sbarro

Fast Food Italian

630-495-2776

Sandwiches \$4-8; Entrees \$5-8

Also serves pizza

(whole and by the slice)

[www.sbarro.com](http://www.sbarro.com)

#### Subway

Fast Food / Sub Sandwiches

Sandwiches \$3-8

#### Taco Bell

Fast Food / Mexican

Tacos/Burritos \$1-4; Salads \$5-6

#### Yogen Fruz

Fast Food / Frozen Treats

Frozen yogurt; \$3-6

All You  
Can Eat

## Buffet!

No need to leave the convention for food! This year the Westin Hotel has set up an all you can eat buffet for WindyCon attendees. Lunch will be served on Saturday and Sunday. Dinner will be served on Friday and Saturday. Details will be available at the Information Desk.

Junior Ballroom C

Lunch \$13.00 ~ Dinner \$15.00

# CYPHAN

SCIENCE FICTION &  
FANTASY UNITED

June 25-27, 2010

Westin Chicago  
North Shore

Wheeling, IL

## ***PARTY AMONG THE STARS!***



**COME MEET BATTLESTAR GALACTICA'S**

# NICKI CLYNE

**AND FROM FIREFLY / SERENITY & SG ATLANTIS**

# JEWEL STAITE



### ***OTHER HIGHLIGHTS:***

- 11,000 sq ft Dealer Hall
- Celebrity Guests (Q&A, Autographs, Photo Ops)
- Droid Hunt (sponsored by the 501st M WG)
- Costume Contest (Friday night, 18 and older)
- Imperial Ball (Saturday night, 18 and older)
- Bounty Hunt (aka: Jail n' Bail)
- Cantina (18 and older)
- Role Playing Games Room
- Browncoat Bash (VIP Party with Jewel Staite!)
- Movie Room
- Seminars / Workshops
- Fan Group Display Hall (free display space!)

**More info and advanced tickets: [www.cyphan.com](http://www.cyphan.com)**

## ATTACHED TO YORKTOWN MALL

With Outside Entrances  
So they have their own hours.

### Adobo Grill

Mexican  
630-627-9990  
F & SA 11am - 11pm,  
SU 11am -9pm  
Entrees \$13-22  
www.adobogrill.com

### Brio Tuscan Grille

Italian  
630-424-1515  
F & SA 11am - 11pm,  
SU 11am -10pm  
Sandwiches \$10-14; Entrees \$15-30  
www.brioitalian.com/menu

### DOC Wine Bar

Upscale American,  
Late Night Kitchen  
630-627-6666  
F & SA 11:30am - 2am,  
SU 12p - 11pm  
Sandwiches \$9-10; Entrees \$12-22  
www.docwinebarchicago.com

### Ed Debevic's

Diner  
630-495-1700  
F & SA 11am - 10pm,  
SU 11am - 9pm  
Take Out Taxi  
Sandwiches \$6-10; Entrees \$7-11  
http://bit.ly/1vRIH7

### Egg Harbor Café

Casual Dining, Breakfast  
630-792-0724  
Daily 6:30am-2pm  
Sandwiches \$8-10; Entrees \$5-9  
www.eggharborcafe.com/menu

### Famous Dave's BBQ

630-620-6363  
F & SA 11am - 10pm,  
SU 11am - 8pm  
Take Out Taxi  
Sandwiches \$8-10; Entrees \$9-19  
www.famousdaves.com

### Flat Top Grill

Mongolian BBQ, Breakfast  
630-652-3700  
F 11:00am-10:30pm,  
SA 9:00am-10:30pm,  
SU 9:00am-9:30pm  
Entrees \$9 (L) \$14 (D)  
Saturday and Sunday Breakfast 9-12  
www.flattopgrill.com

### Lucky Strike Lanes

Eclectic Bar Food,  
Late Night Kitchen  
630-916-8681  
Sandwiches \$7-15; Entrees \$7-15  
Reservations / Call Ahead Seating  
F 11:30am-2am (over 21 only after 9)  
SA 11am-2am (over 21 only after 9)  
SU 11am-11:30pm (Over 18 only after 9)  
www.bowlluckystrike.com

### RA Sushi Bar

Sushi  
F & SA 11am-11pm,  
SU 11am-10pm  
Sushi bar \$4-22;  
Entrees \$7-12 (l), \$15-25 (d)  
Take Out Taxi  
www.benihana.com

## MALL OUTLOT

It's a big lot  
You may want to use the shuttlebus.

### Buca di Beppo

Family Style Italian  
630-932-7673  
F & SA 11am - 11pm,  
SU 11am -9pm  
Reservations / Call Ahead Seating  
Sandwiches \$10-12 (L)  
Entrees \$10-15 (L), \$10-30 (D)  
Take Out Taxi  
www.bucadibeppo.com

### Capitol Grille

Steakhouse  
630-627-9800  
F & SA 5pm - 11pm, SU 4pm - 9pm  
Reservations / Call Ahead Seating  
Entrees \$23-45  
www.thecapitalgrille.com

### Claim Jumper

Upscale American  
630-932-4290  
F & SA 11am - 11pm,  
SU 11am - 10pm  
Take Out Taxi  
Sandwiches \$10-15; Entrees \$10-31  
www.claimjumper.com

### Frankie's Deli

Italian deli.  
Sandwiches, salads and  
some grocery items.  
630-627-7977  
M-F 9am-8:30pm, Sa 9am-5pm,  
Su 11am-4:30pm

### Rock Bottom

Brew Pub, Late Night Kitchen  
630-424-1550  
F & SA 11am - 2am, SU 11am - 1am  
Sandwiches \$9-\$11; Entrees \$12-\$23  
www.rockbottom.com

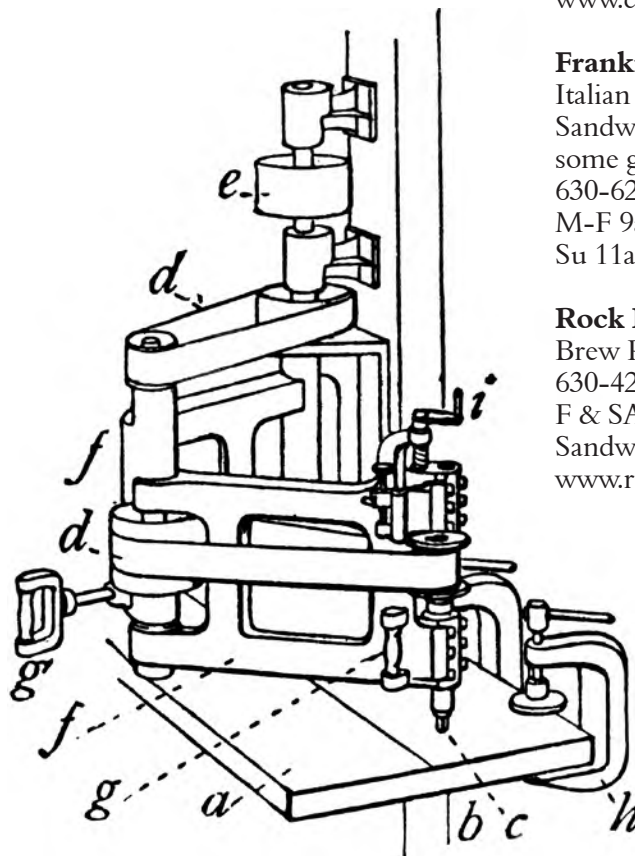

# ConClave 35

Science Fiction & Fantasy Literary Convention

October 8-10, 2010



## Omnibus GOH: Juanita Coulson

One of ConClave's favorite people and most versatile guests. Author of such works as *Fear Stalks the Bayou*, *Dark Priestess*, *The Web of Wizardry*, *The Death God's Citadel*, *Fire of the Andes*, the *Children of the Stars* series, *Star Sister*, *Shadow Over Scorpio*, and others. Pegasus Award-winning filker and songwriter. Hugo-winning editor of fanzine *Yandro*.

## Fan GOH: Doug Lughart (aka L. Warren Douglas)

Loyal fan and wonderful guy. And in his other identity, author of *The Sacred Pool*, *The Veil of Years*, *The Isle Beyond Time*, *Bright Islands in a Dark Sea*, *Simply Human*, *Glaice*, and others.

## Artist GOH: Peri Charlifu

Multitalented award-winning artist. Paintings and sculpture and hand-painted stoneware and pottery and ... Well, you just have to come and see it! One of the friendliest guests you could ever hope to meet.

---

**Rates:        \$40 for now**

**Hotel:        Crowne Plaza Hotel**  
8000 Merriman Road, Romulus, MI  
Telephone: (734) 729-2600



**ConClave, Inc., P.O. Box 2915, Ann Arbor, MI 48106-2915**

E-mail us at [con.info@conclavesf.org](mailto:con.info@conclavesf.org). Updates at: <http://www.conclavesf.org>

# STAFF LIST

## Office of the Chair

*Convention Chair* - Joseph Stockman

*Vice-Chair* - Richard France

*Treasurer* - Tom Veal

*Ombudsman* - Sunshine Levy

*Charity Liaison* - Phaedra Meyer

*Asst. Charity Liaison* - Charles Spengler

## Adult Supervision

*Head* - Cassi Vestweber

*Asst. Head* - Robert Wadowski

*Asst. Asst. Head* - Garrett Sullivan

*Staff* - Jonathan Gustafson

*Staff* - Matthew Carroll

*Staff* - Moises Mercado

## Art Show, Auction & Print Shop

*Head* - Kerry Kuhn

*Second* - Melissa Clemmer

*Staff* - Yoel Attiya

*Staff* - Heather Leatherman

*Staff* - Marie Plant

*Staff* - Cheryl Storm

*Staff* - Nancy Riggs

*Staff* - RJ Johnson

## Child Care

*Head* - Amy Wenshe

*Second* - Vicki Bone

## Con Suite

*Proprietor* - Brent Warren

*Asst. Proprietor* - Saeri Geller

*Staff* - Jesse Babb

*Staff* - Christine Battin

*Staff* - Orlando Belisle

*Staff* - Dan Conteras

*Staff* - Myron Deutch

*Staff* - Corey "Anon" Hess

*Staff* - Jason "Jazz" Jenson

*Staff* - Erich Krieger

*Staff* - Debbie Landmann

*Staff* - Rachel Landmann

*Staff* - Brian "Gyu" Lee

*Staff* - William Pleas

*Staff* - Scott Schultz

*Staff* - Dana "Kas" Shields

*Staff* - Shannon Siebert

*Alemaster* - Andrew Scheeler

*Staff* - Renee Scheeler

*Staff* - Rania Baxter

*Staff* - John Sandstrom

*Staff* - Kate Schultz

*Staff* - Pixie Walker

*Staff* - Nicole Yates

## Dealer's Room

*Head* - Mike Jencevice

*Second* - Bill Jorns

*Staff* - Brendan Lonchawk

*Staff* - Gloria Dill

*Staff* - Marta Rose

*Staff* - Merlanne Rampale

*Staff* - Barb Darrow

## Gophers

*Gopher Wrangler* - Cassandra Benedict

*Second* - Data Hawk

*Staff* - Devin Murphy

*Staff* - Patricia O'Neill

*Staff* - Tim Mithee

*Staff* - Chris DeVuono

## Guests

*Guest Liaison* - Steven H Silver

*Second* - Elaine Silver

## Hotel

*Hotel Liaison* - Phoenix

*Second* - Jessica Monaghan

*Party Liaison* - Elena Persian Aceves

## Information Booth

*Head* - John Donat

*Second* - Erika Donat

*Restaurant Guide* - Kathy Horning

*Restaurant Guide* - Jim Rittenhouse

## ISFiC Press

Steven H Silver

Bill Roper

Bob Garcia

John McCoy

Pat Sayre McCoy

Anne Zanoni

## Logistics

*Head* - Taz Dobbin

*Second* - Richard "Drake" Lambert

*Staff* - Jason "Cricket" Williams

*Staff* - Chris Pogorski

*Staff* - Scott "+1" Mellor

*Staff* - Beryl "Krag shot" Turner

*Staff* - Chase "Irish" Ferguson

*Staff* - Todd "Surge" Choryan

## Operations

*Head* - Ken Hunt

*Second* - Sandra Woggon

*Staff* - Denis Rogan

## Programming

*Programming Chair* - Pat Sayre McCoy

*Programming Operations* - Anne KG Murphy

*Programming Troubleshooter* - Erik V. Olson

## Anime

*Head* - John Fritz

*Staff* - Sheila Horne

*Staff* - Judy Seidl

## Computer Gaming

*Head* - Paul Lyn-Waitsman

*Staff* - Sean Ihnat

## Childrens Programming

*Childrens Programming Chair* - Lisa Ragsdale

*Childrens Programming Second* - Matthew Ragsdale

## Filk

*Head* - Betsey Langan

*Second* - Angela Karash

## Films

*Head* - David Hoshko

*Second* - Mike Hanson

*Staff* - Mary Mascari

## Gaming

*Head* - Alex Bailey-Mathews

*Staff* - Patrick "Reaper" Finnegan

*Staff* - Tom "Midnight v2.0" Fallucca

*Staff* - Gail 'Shadow Cat' Mathews-Bailey

*Staff* - Matt 'Whipped' Harbage

## Green Room

*Head* - Ann Totusek

*Staff* - Gerilyn Meany Bartnik

*Staff* - Dan Steinkellner

*Staff* - David West

*Staff* - Richard West

*Staff* - David Schroth

*Staff* - Joe Nagler

*Staff* - William Homblad

*Staff* - Tom Ridley

*Staff* - Brigid Strait

## LARP

*Lead* - Shaina Lyn-Waitsman

*Lead* - Daniel Levin

*Staff* - Paul Lyn-Waitsman

*Staff* - Wilder Green-Tsuhako

## Publications

*Head* - Deb Kosiba

## Registration

*Head* - Rick Waterson

*Second* - Susie France

*Staff* - Rebecca Weeks

*Staff* - Lois Ray

*Staff* - Krista Cobb

*Staff* - Kim Williams

## Special Events

*Coordinator* - Bill Roper

*Second* - Bonnie Jones

*Staff* - Gretchen Roper

*Masquerade Director* - Wendy Zdrodowski

*Masquerade Green Room* - Bill Dunbar

## Technical Services

*AV Tech* - David Ifversen

*Second* - Angela Karash

*Tech Crew* - Ron Winsauer

*Tech Crew* - Liana Winsauer

*Information Technology / Network Support* - Ken Beach

*IT Staff* - Phred

*WebMaster* - John McCoy

## ISFiC Writer's Contest

*Administrator* - Marcy Lyn-Waitsman

